

图版 1 入谷墓地 ①-(1)

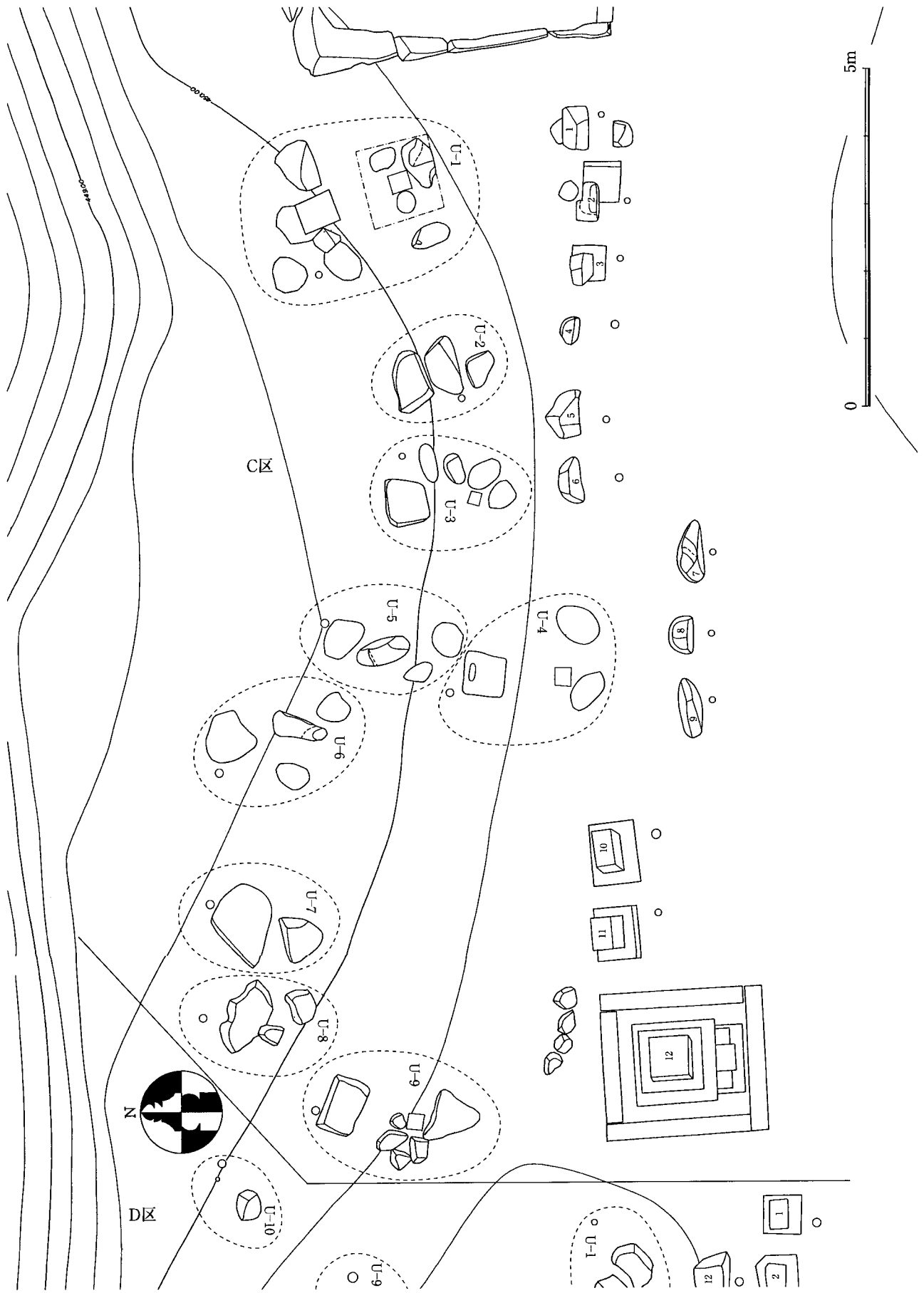

図版2 入谷墓地 ①-(2)

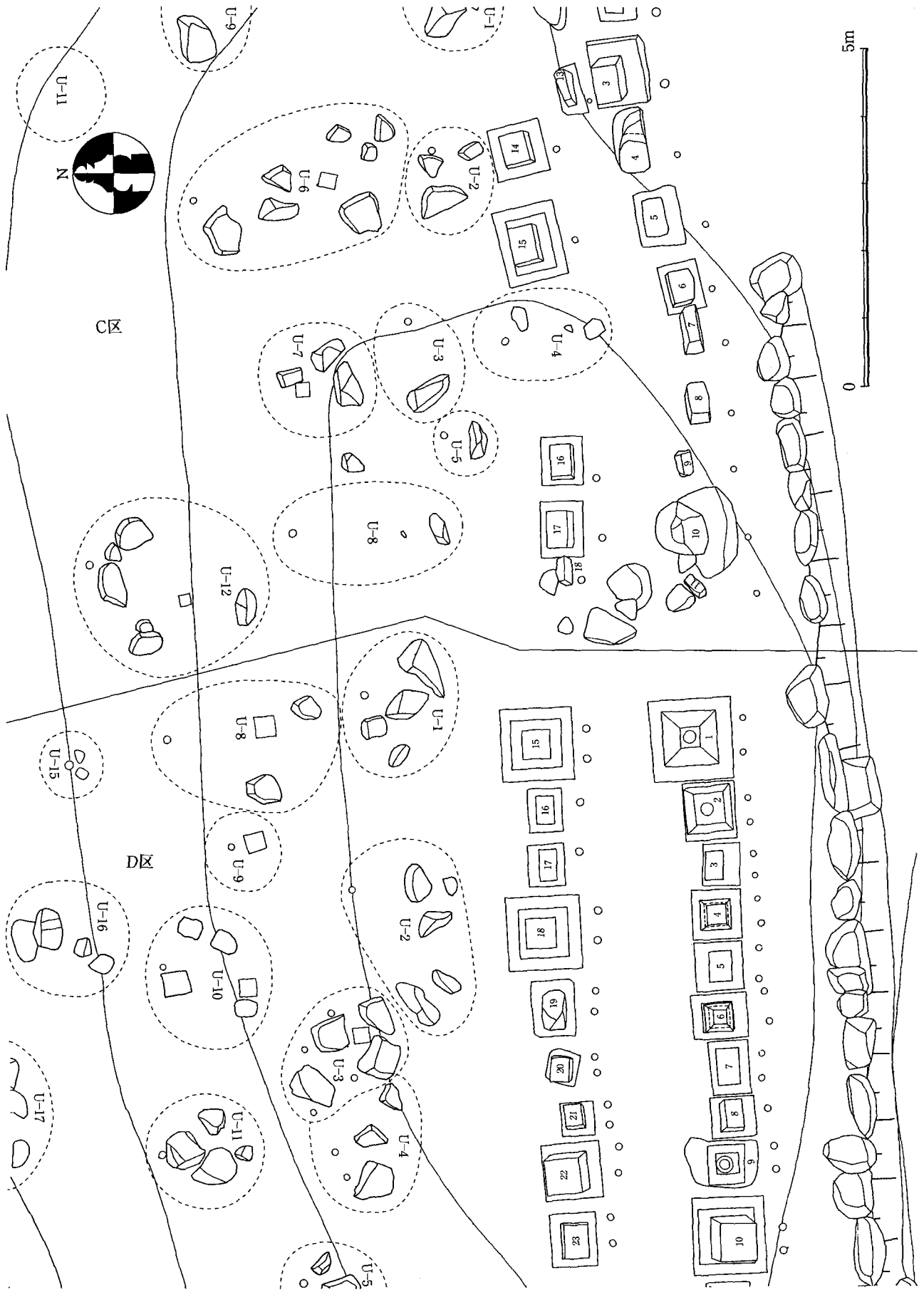

图版 3 入谷墓地 ②(1)



图版 4 入谷墓地 ②-(2)



图版 5 入谷墓地 ②-(3)

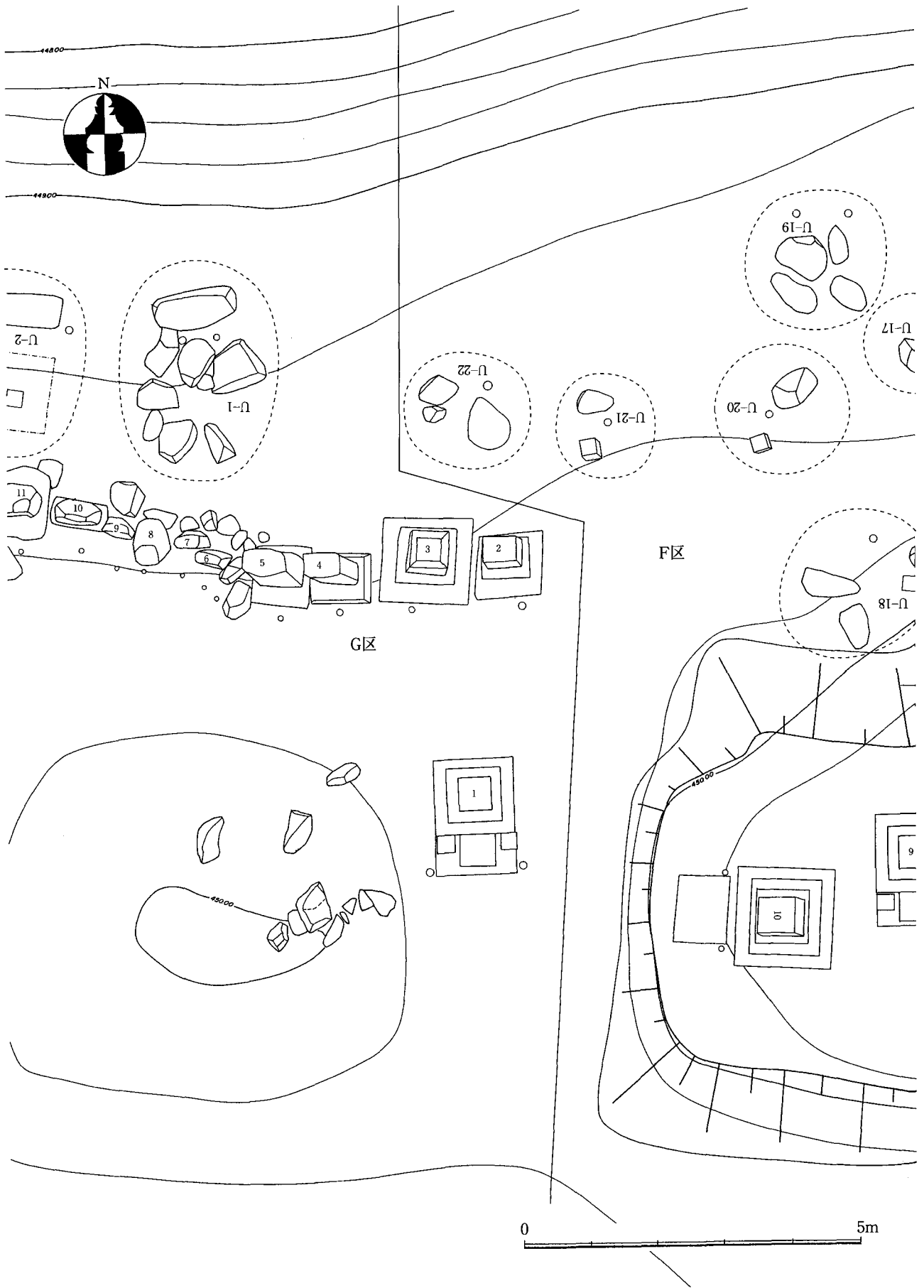

图版 6 入谷墓地 ③-1)

図版 7 入谷墓地 ③-(2)

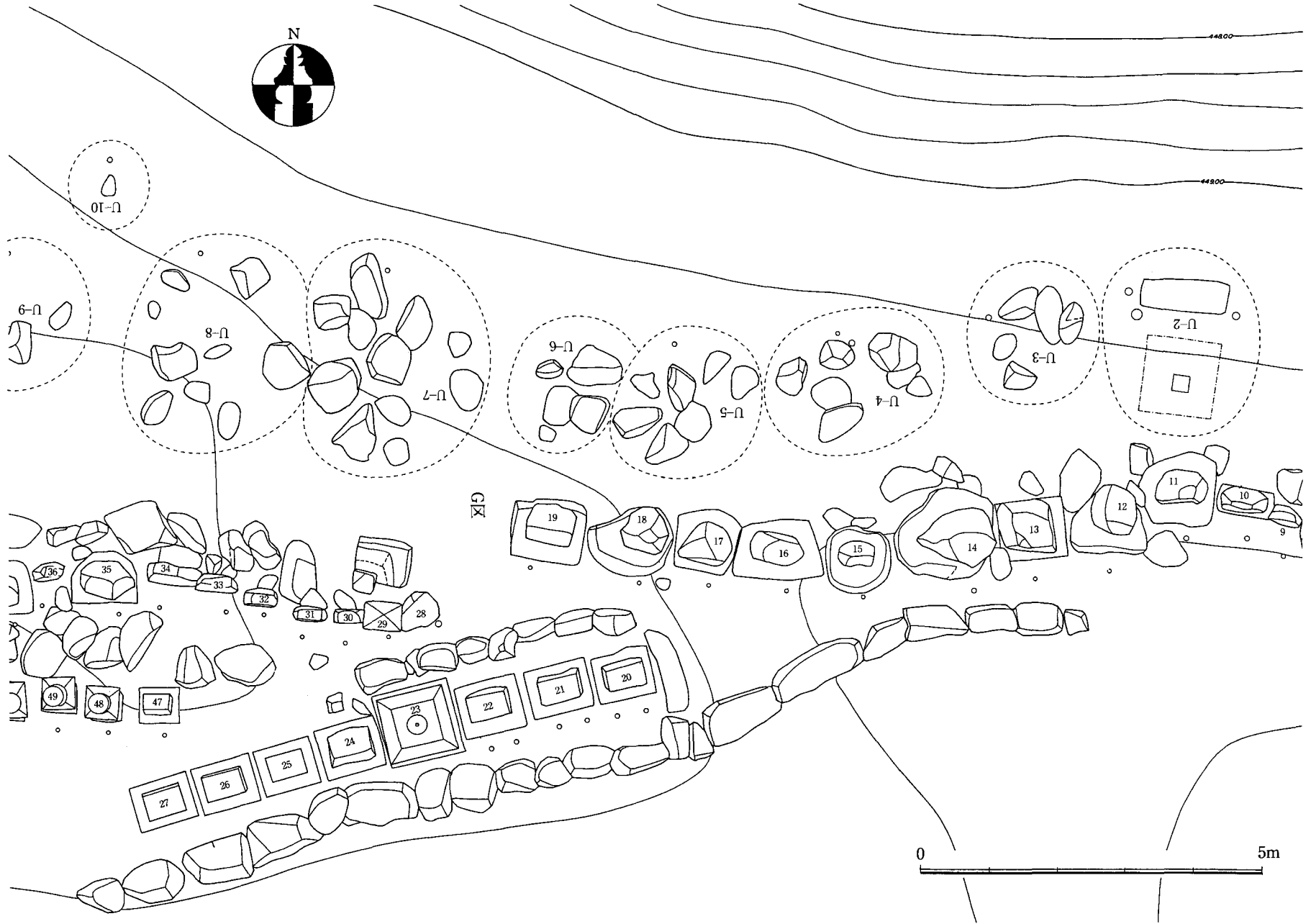

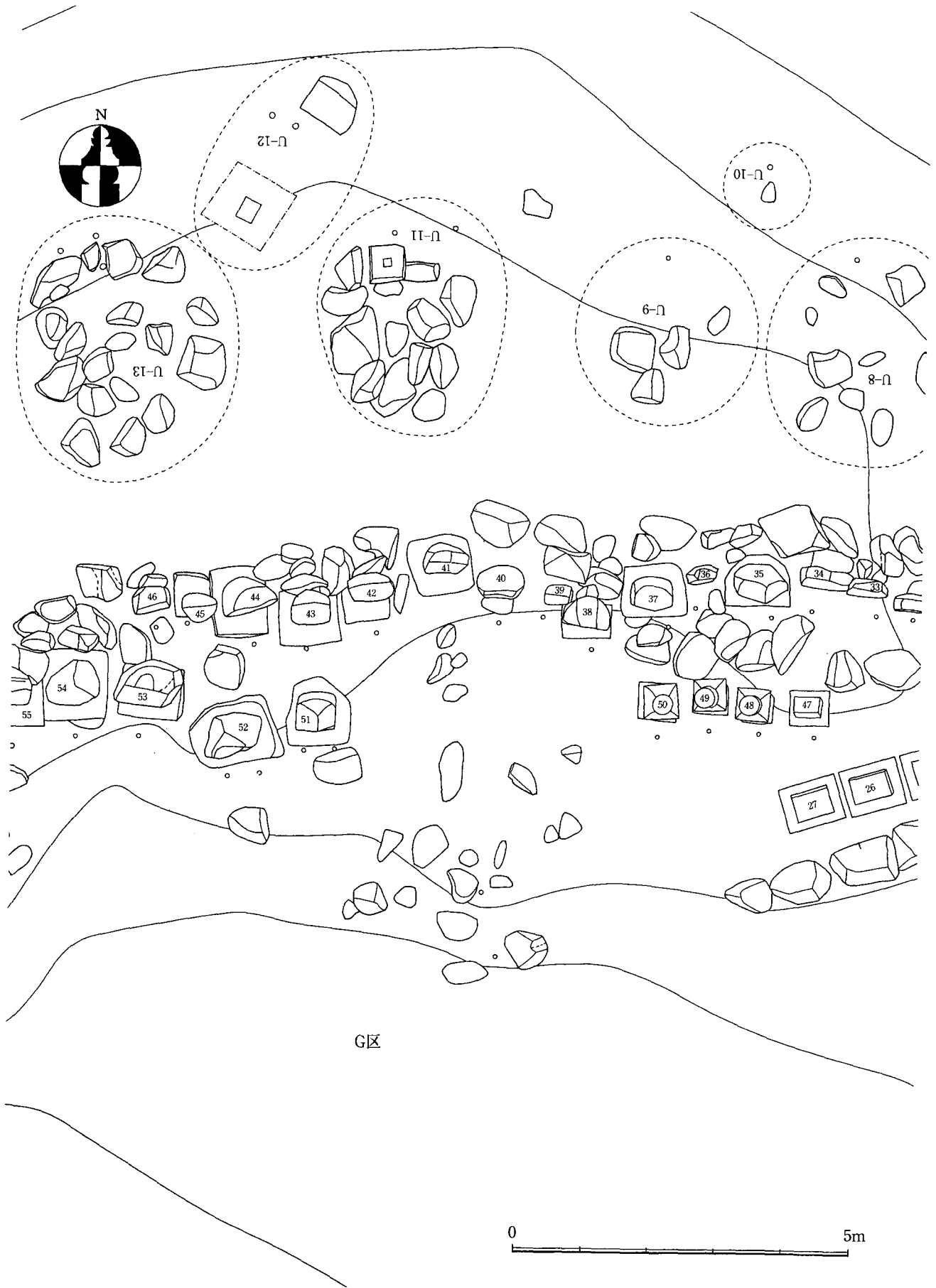

図版 8 入谷墓地 ③-(3)

図版 9 入谷墓地 ④-(1)



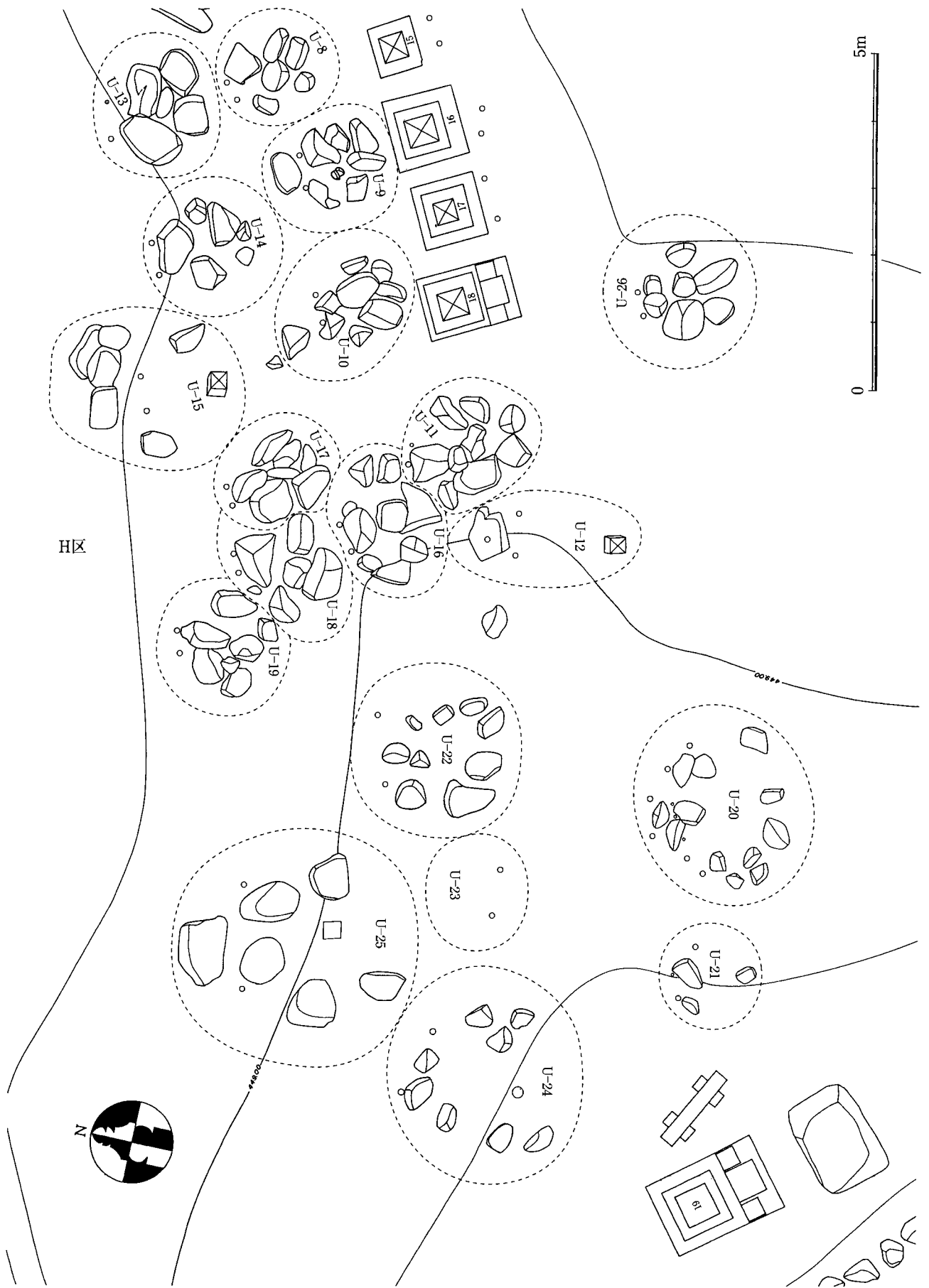

图版 10 入谷墓地 ④-(2)

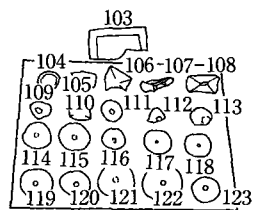
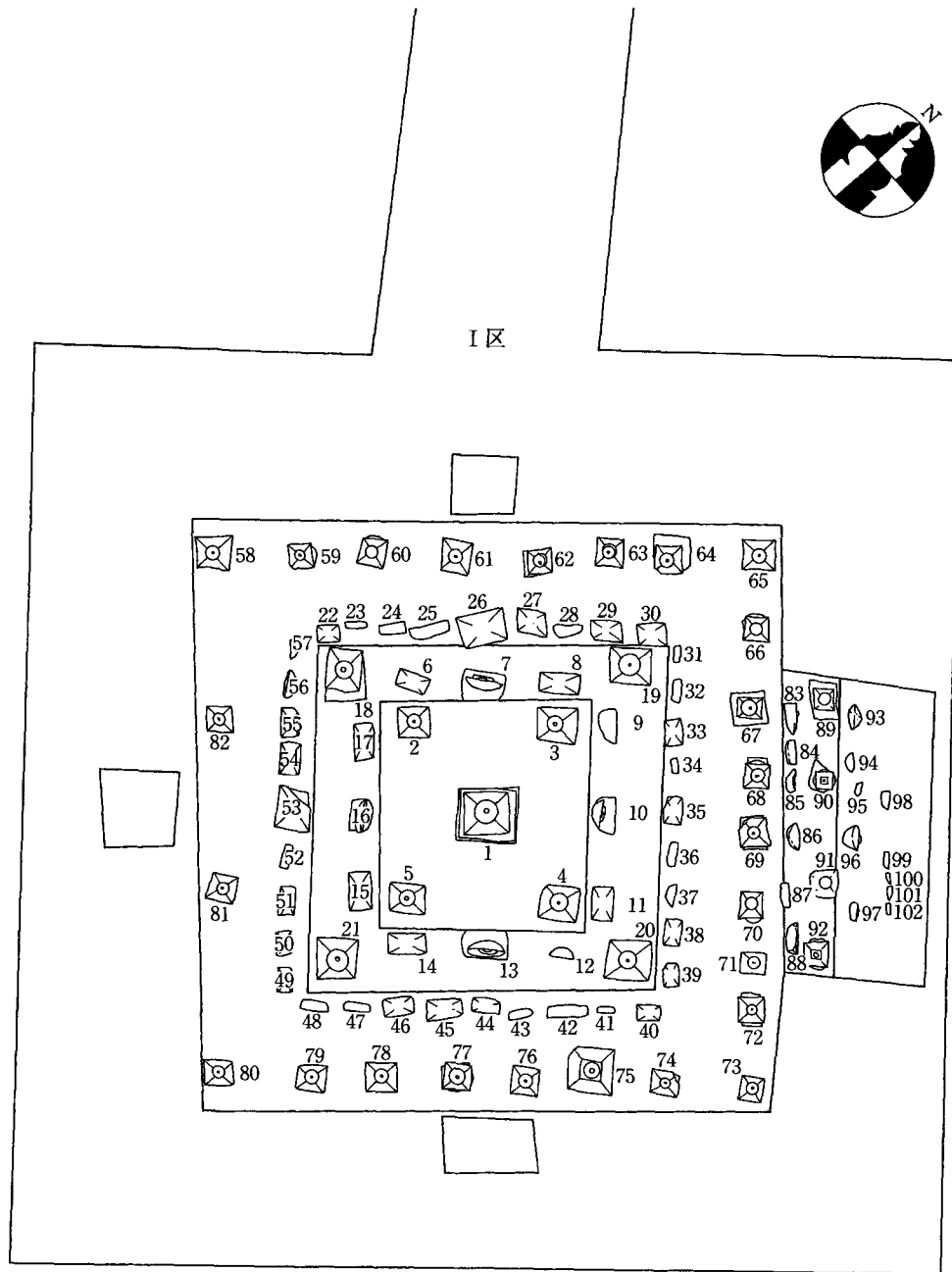

図版 11 入谷墓地 ④

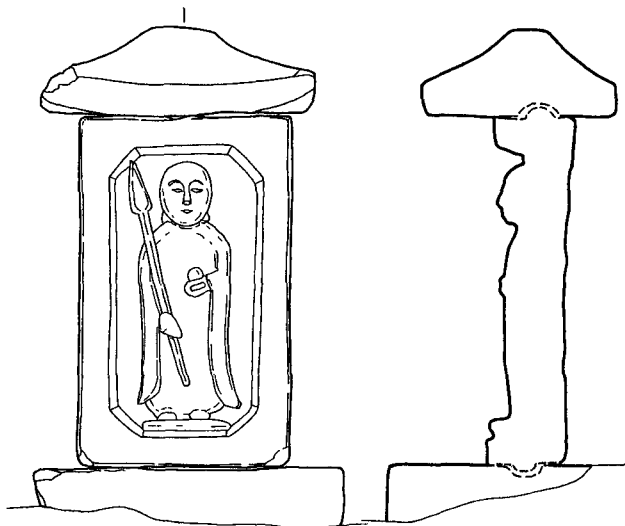

1 箱仏 (I-53)

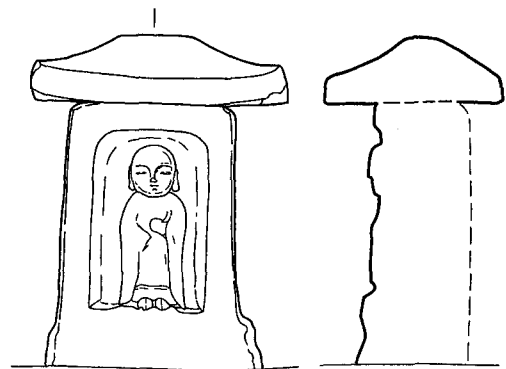

5 箱仏 (I-17)

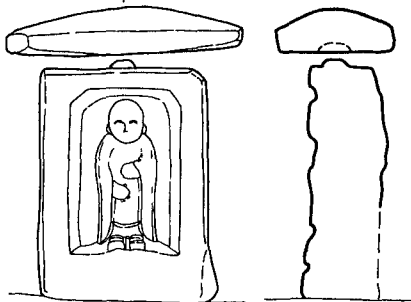

2 箱仏 (I-54)

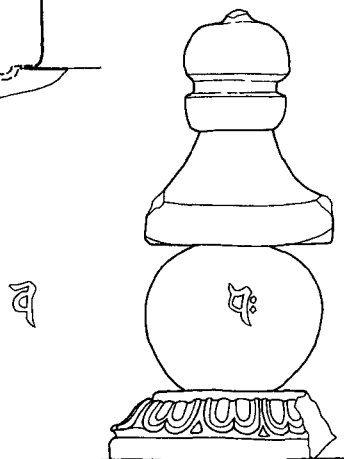

6 別石五輪塔 (I-64)

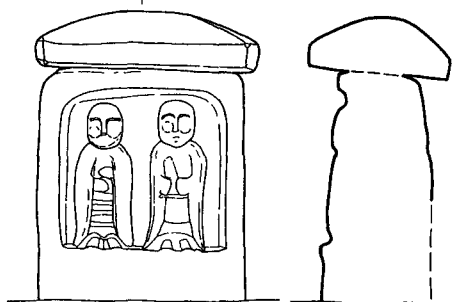

3 箱仏 (I-51)

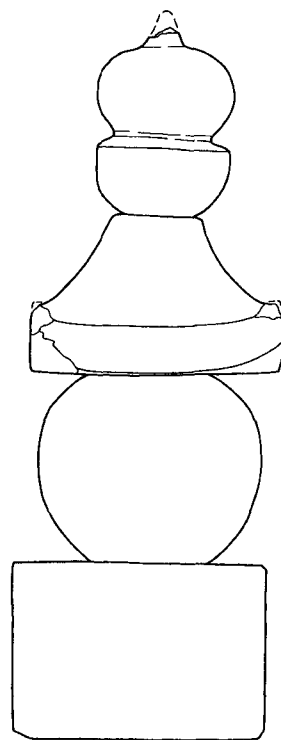

7 別石五輪塔 (I-19)

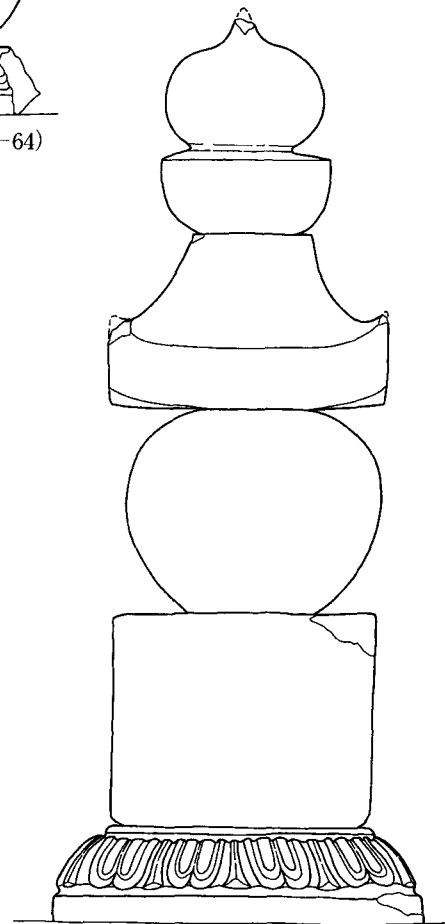

8 別石五輪塔 (I-1「金兵衛さん」)

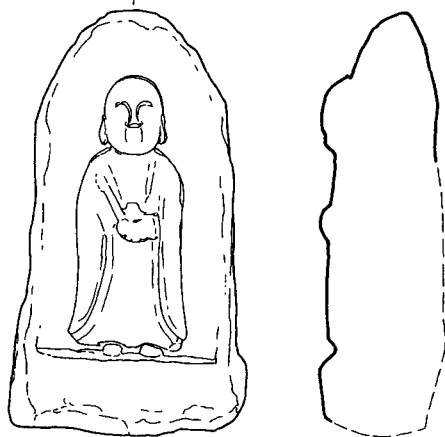

4 有像舟形 (I-16)

0 1/10 50cm

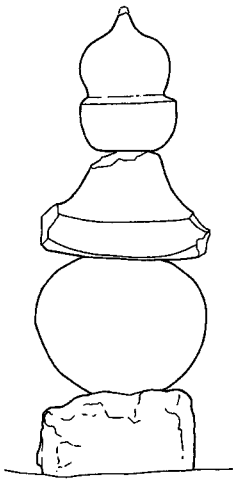

1 別石五輪塔 (I-76)

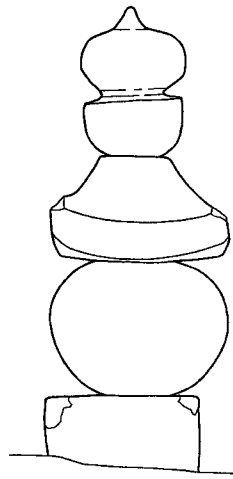

2 別石五輪塔 (I-79)

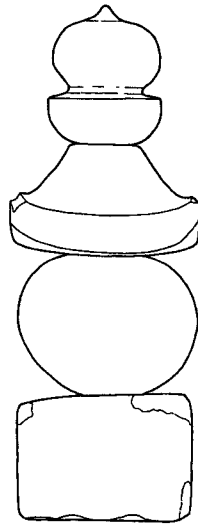

3 別石五輪塔 (I-81)

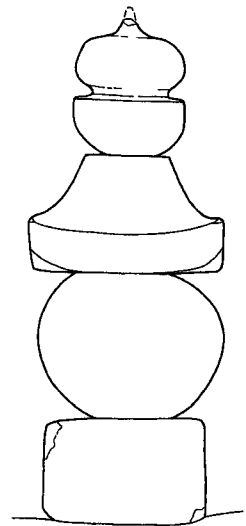

4 別石五輪塔 (I-78)

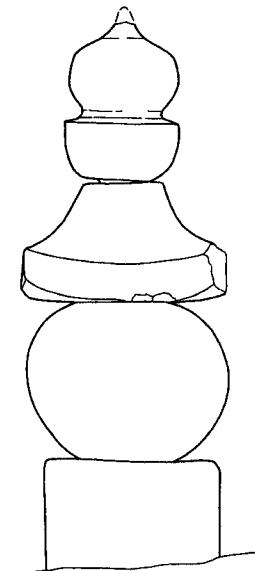

5 別石五輪塔 (I-82)

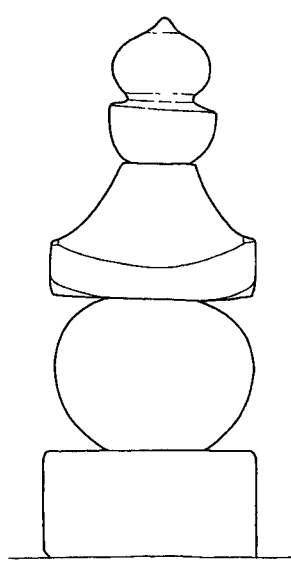

6 別石五輪塔 (I-80)

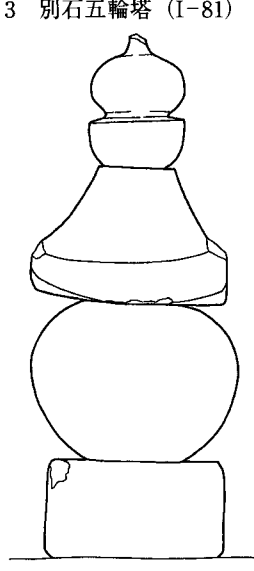

7 別石五輪塔 (I-73)

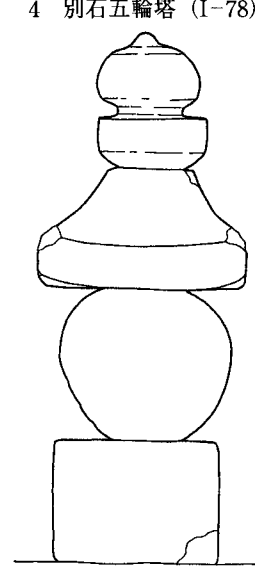

8 別石五輪塔 (I-65)

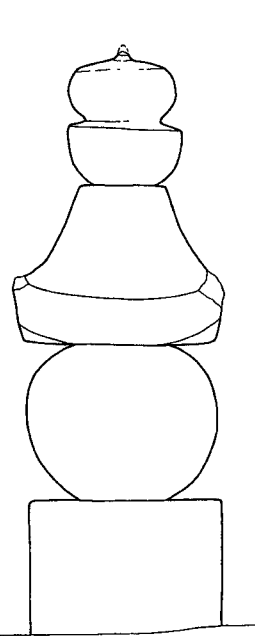

9 別石五輪塔 (I-58)

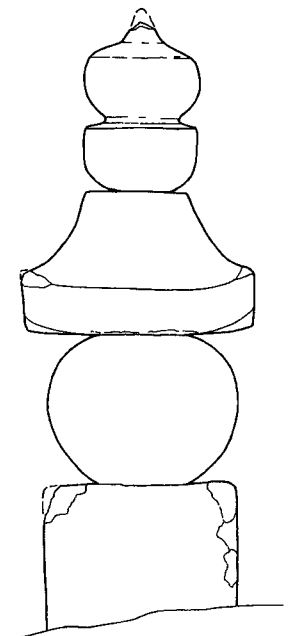

10 別石五輪塔 (I-4)

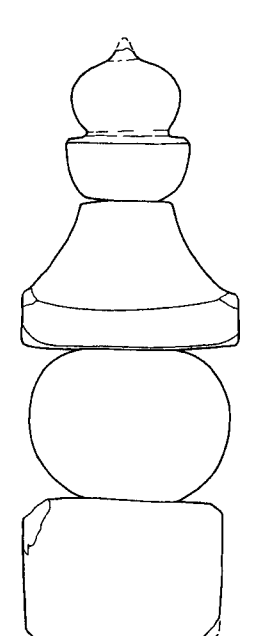

11 別石五輪塔 (I-2)

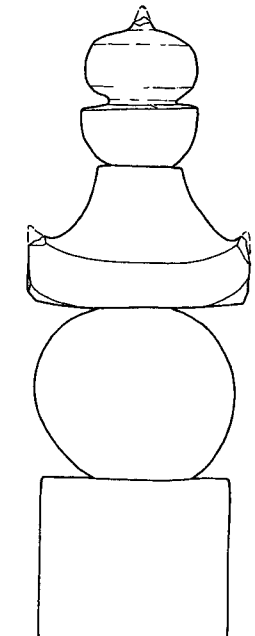

12 別石五輪塔 (I-3)

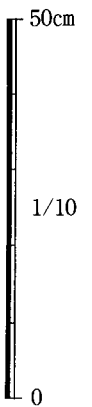

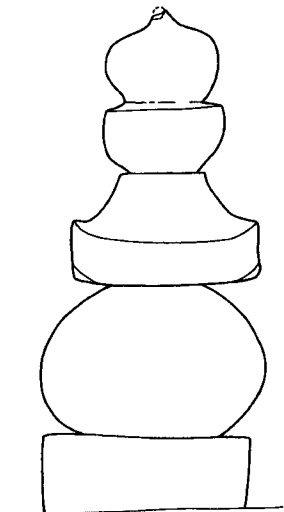

1 別石五輪塔 (G-50)



5 駒形 (G-55, 元禄十六年:1703)

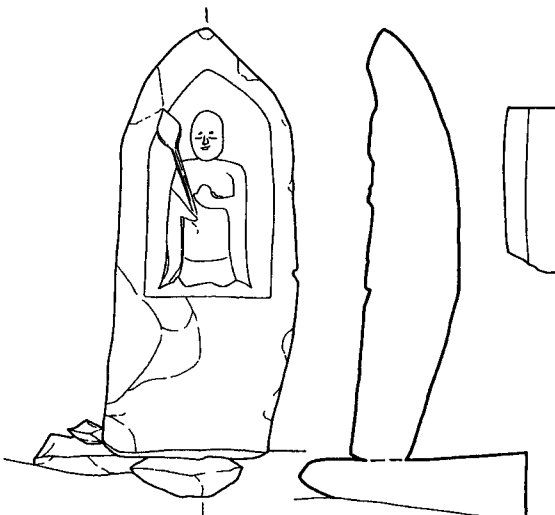

2 有像舟形 (G-45)

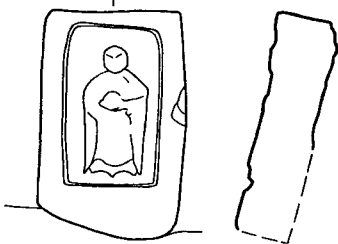

3 箱仏 (G-39)

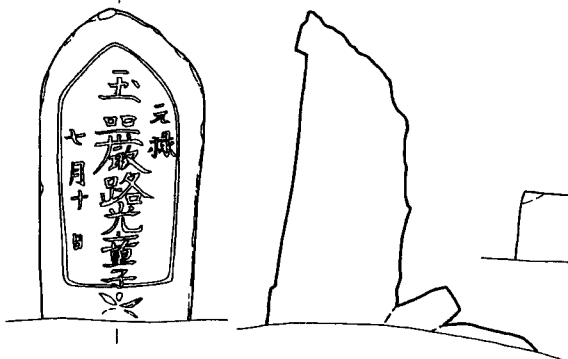

4 舟形 (G-46, 元禄:1688~1703)

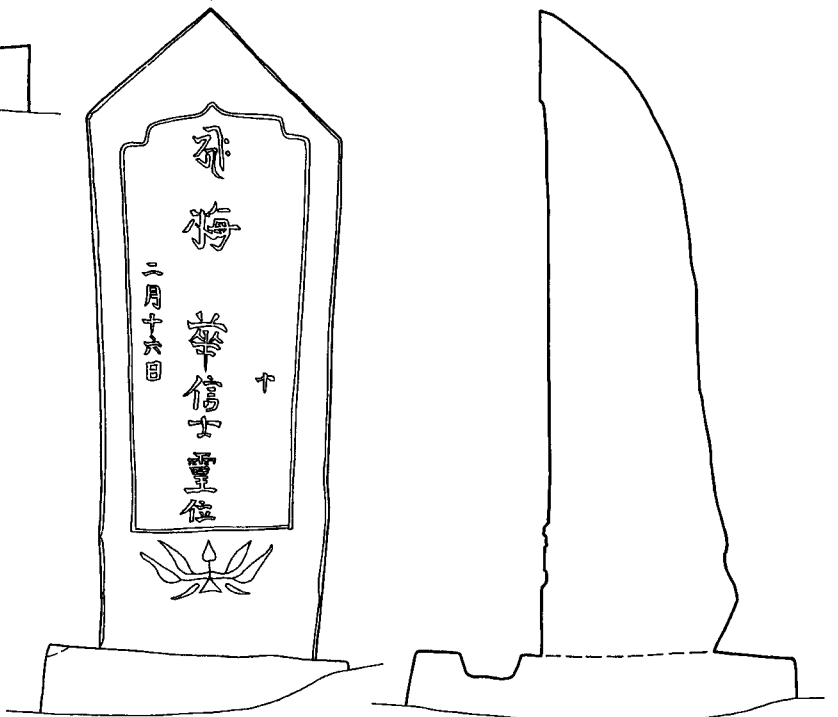

6 駒形 (G-44)

0 1/10 50cm

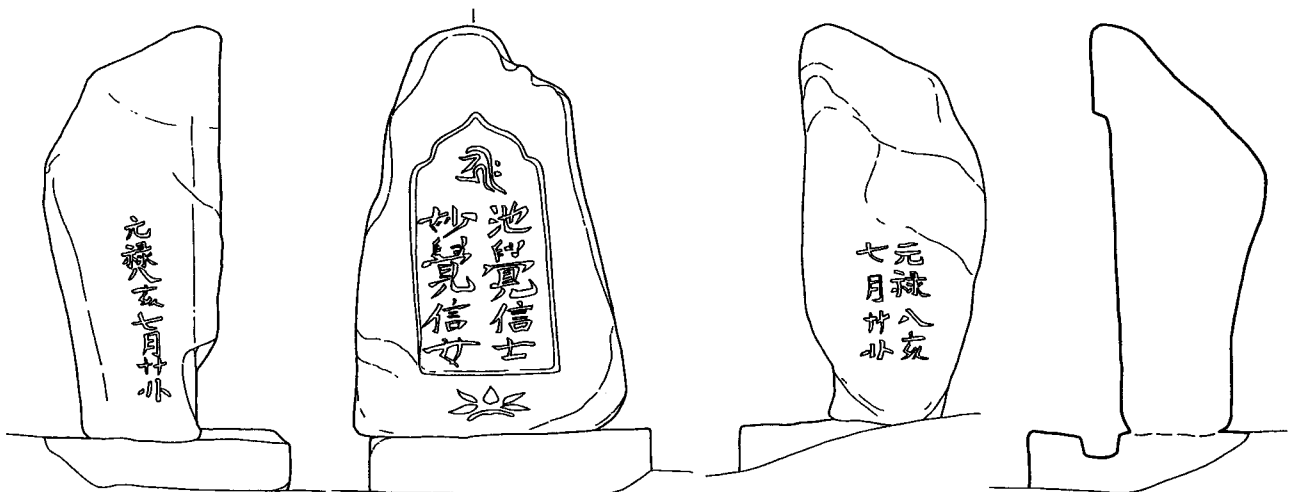

1 自然石 (G-38, 元禄八年: 1695)

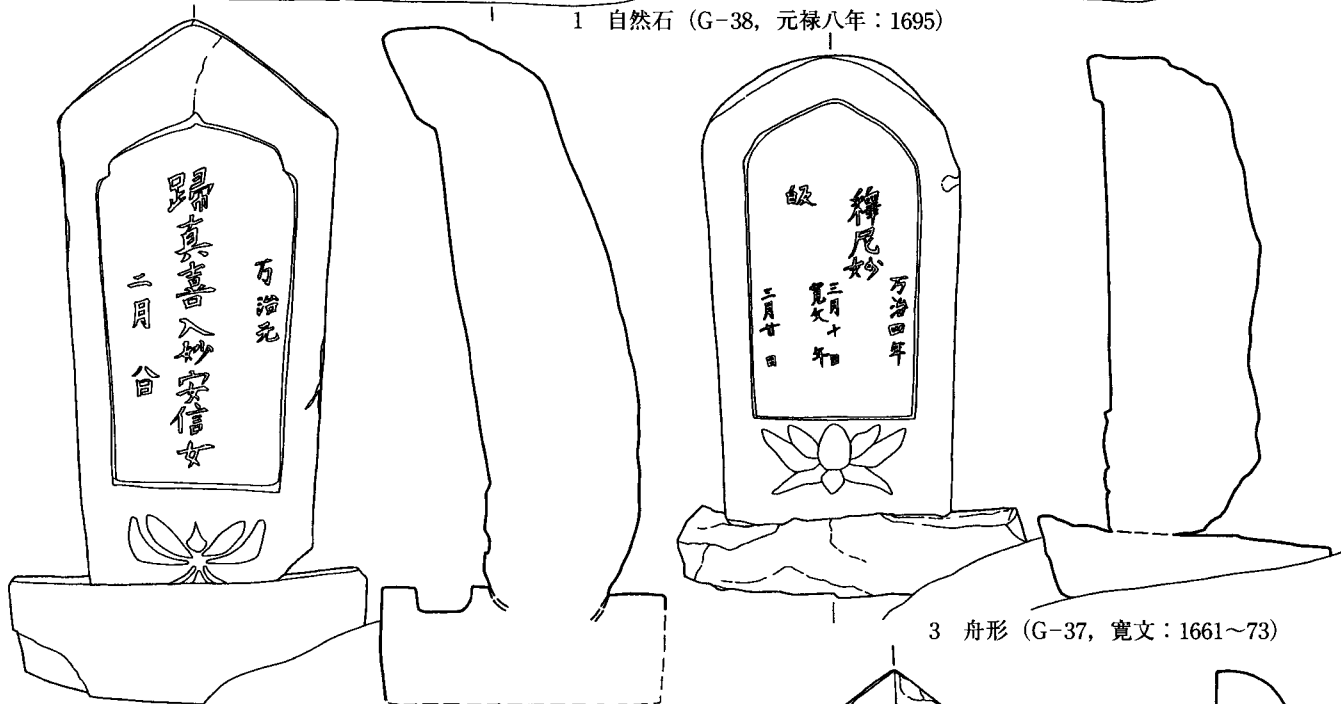

2 駒形 (G-35, 万治元年: 1658)

3 舟形 (G-37, 寛文: 1661~73)

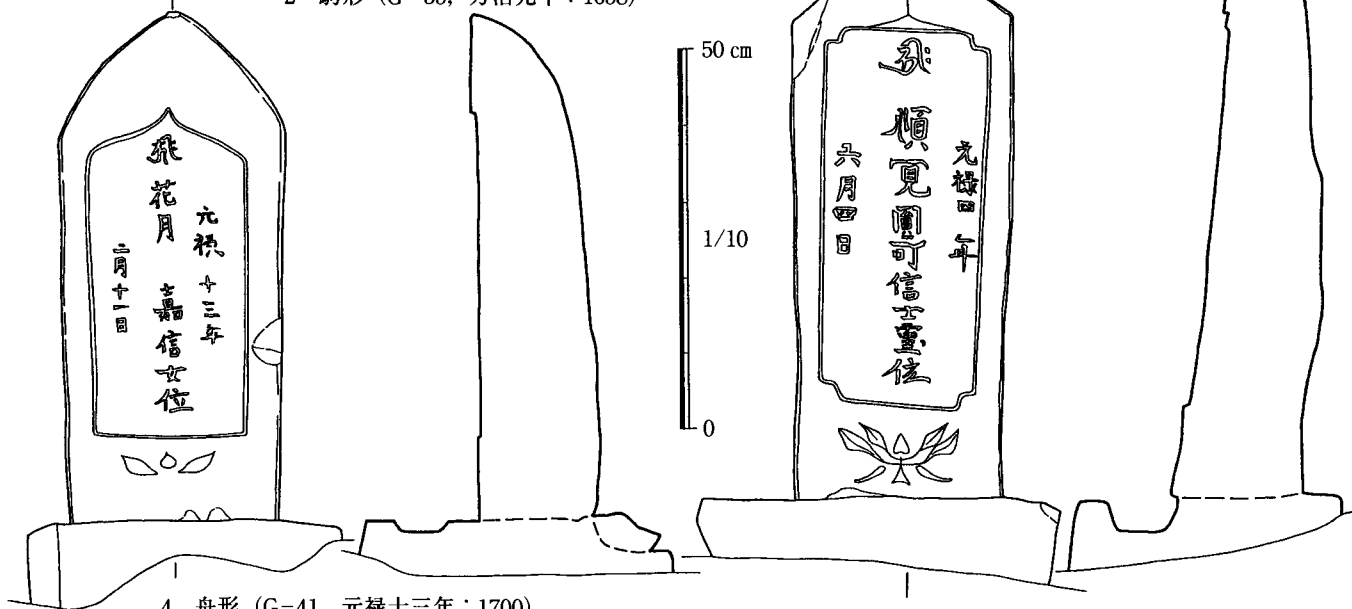

4 舟形 (G-41, 元禄十三年: 1700)

5 駒形 (G-43, 元禄四年: 1691)

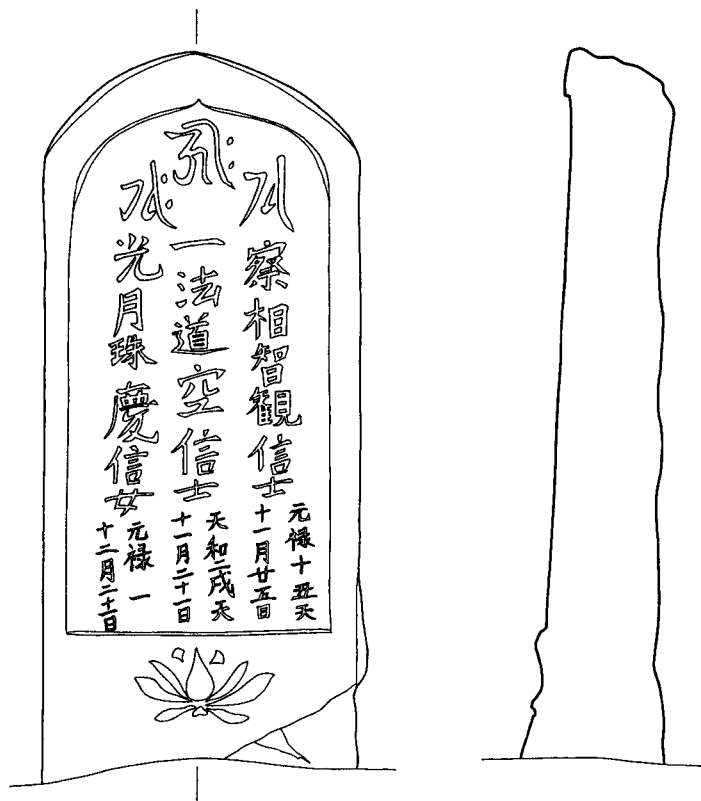

1 舟形 (B-10, 元禄十一年: 1698)

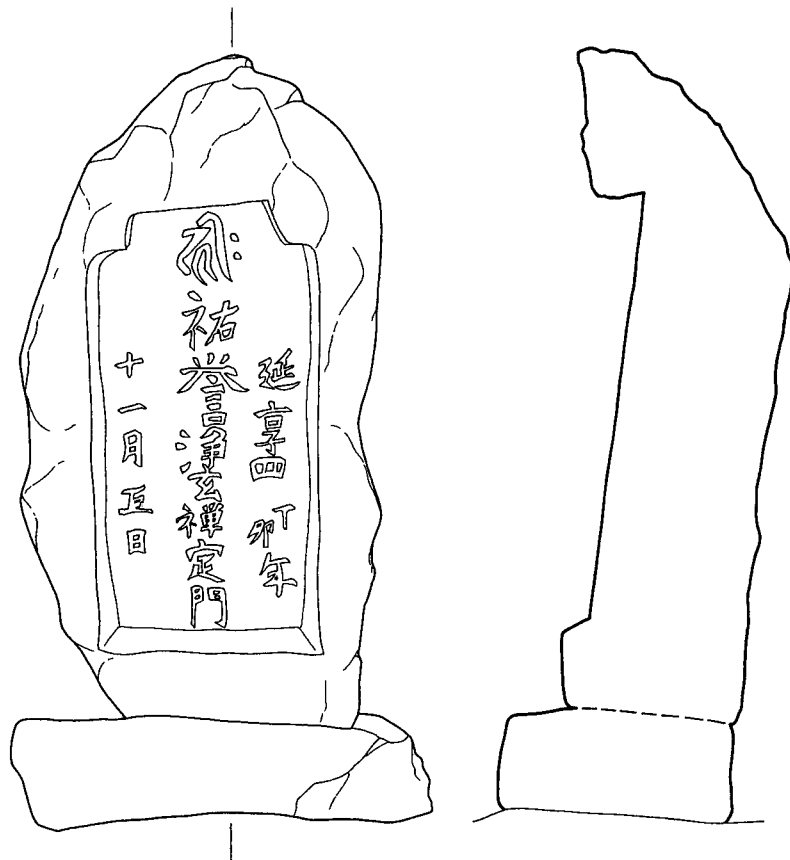

2 自然石 (B-9, 延享四年: 1747)

0 1/10 50cm

図版 17 トナリ遺地 ①-①

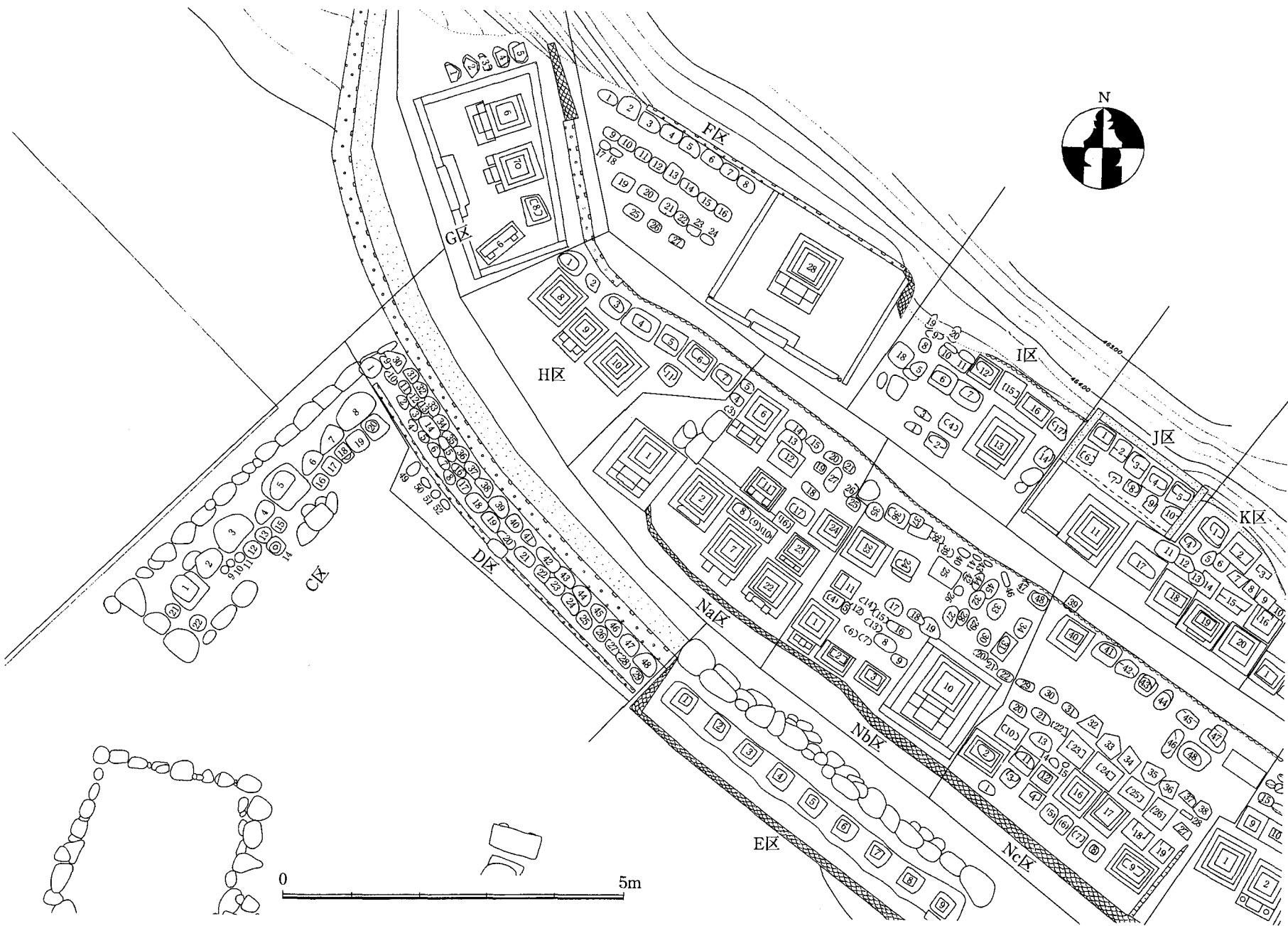

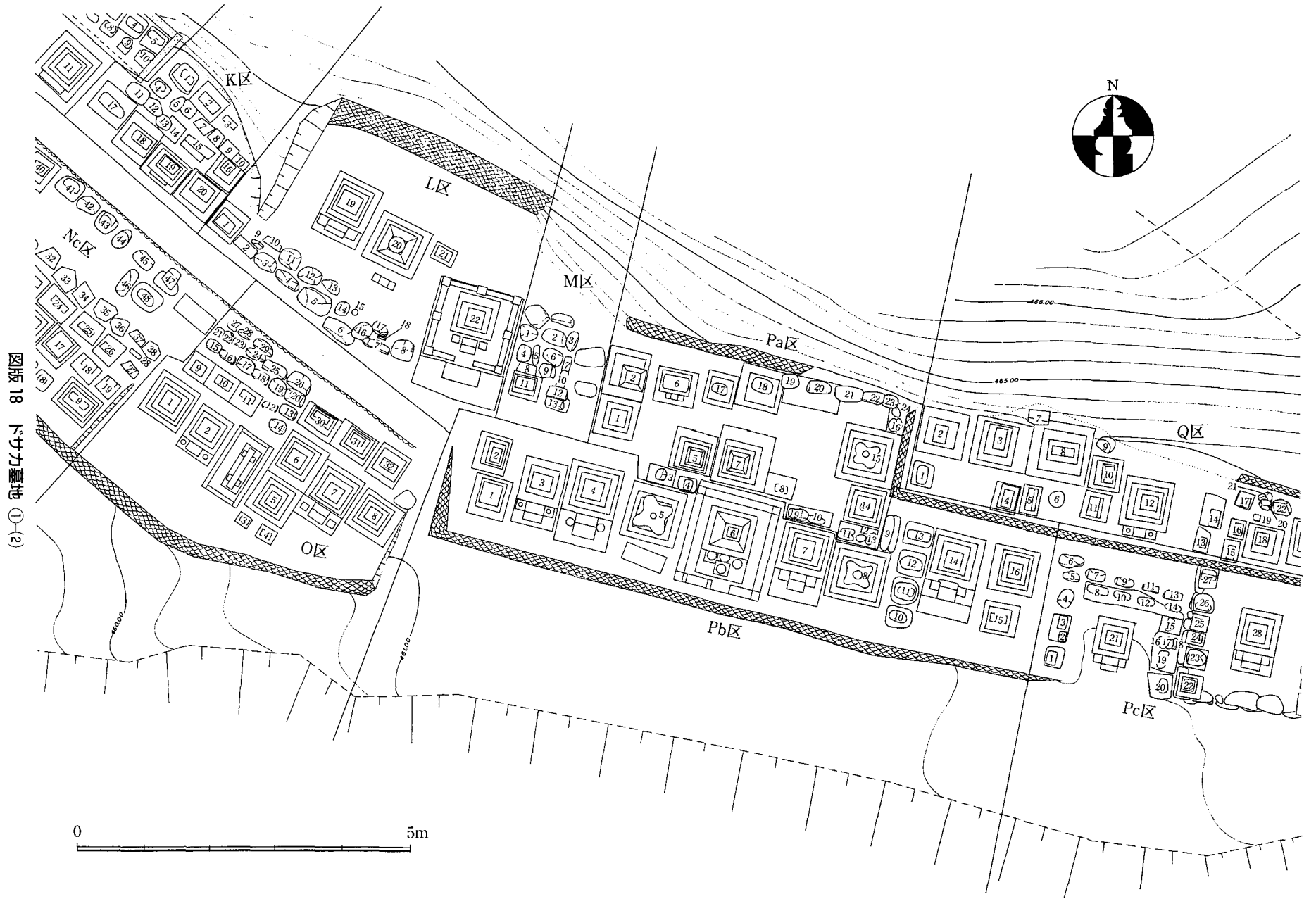

図版 18 ナカフサ遺地 ①(2)



図版 19 トサカ墓地 ②-1)

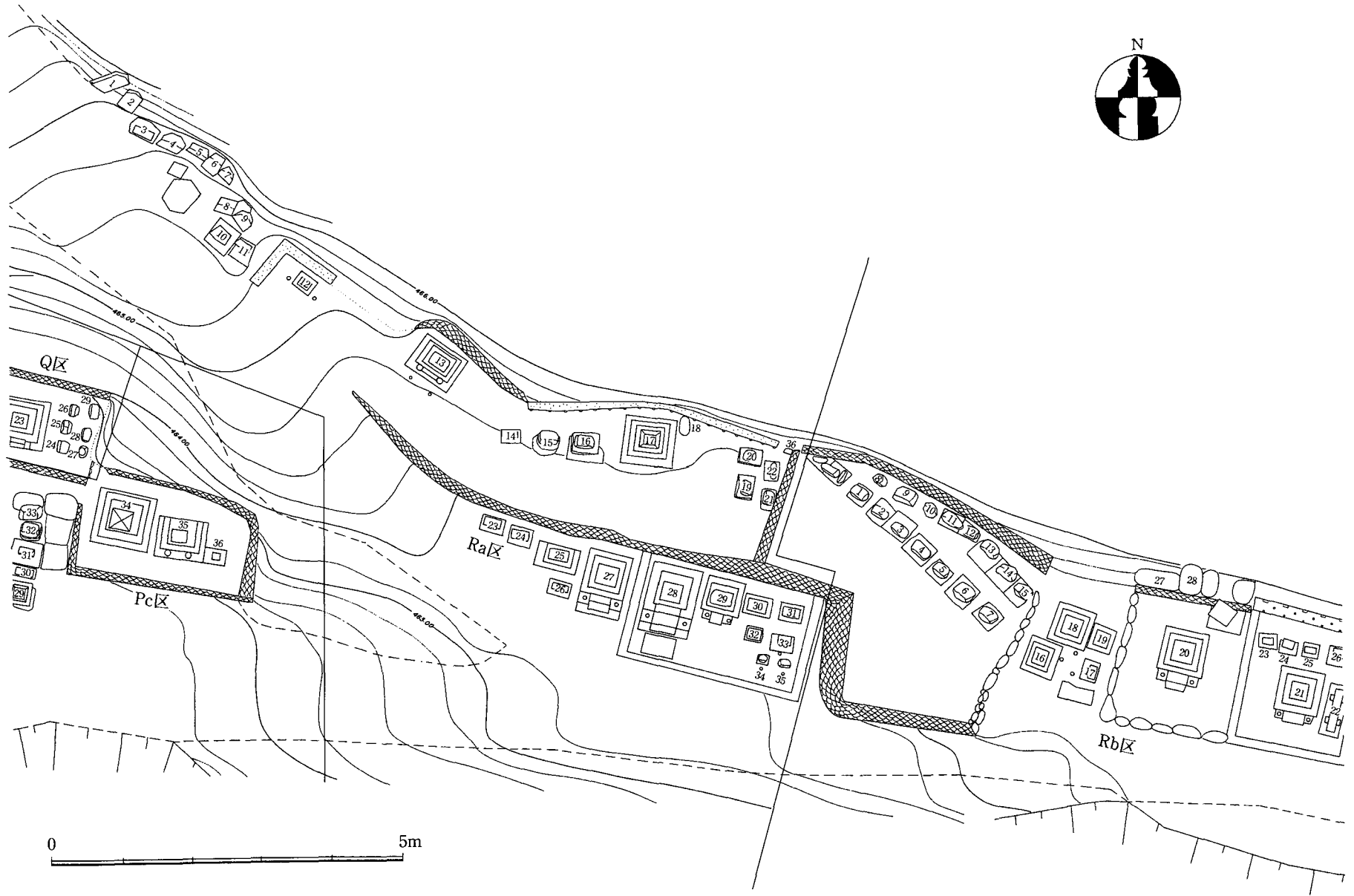

図版 20 トサカ墓地 ②-(2)

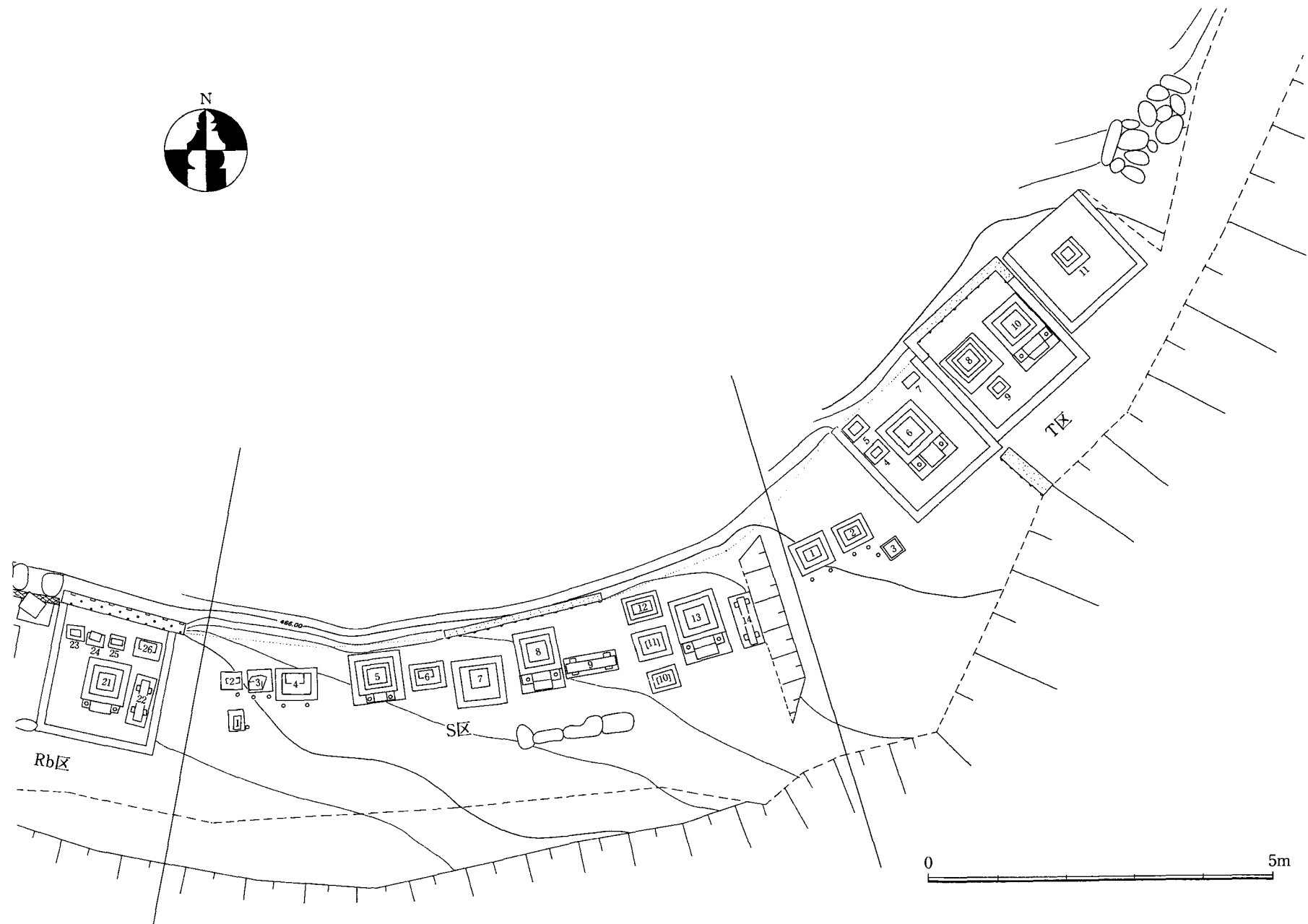

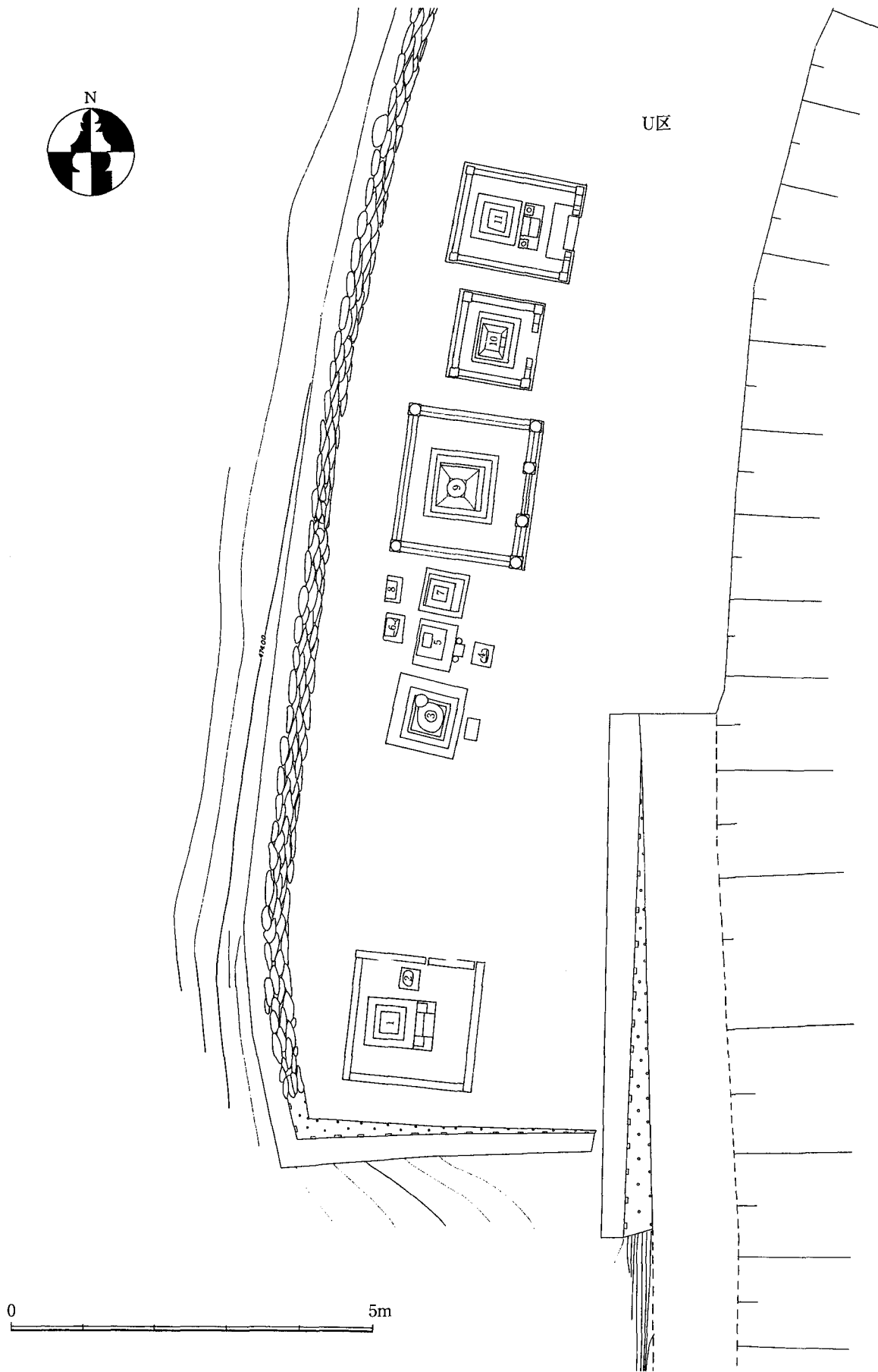

図版 21 ドサカ墓地 ③-1)

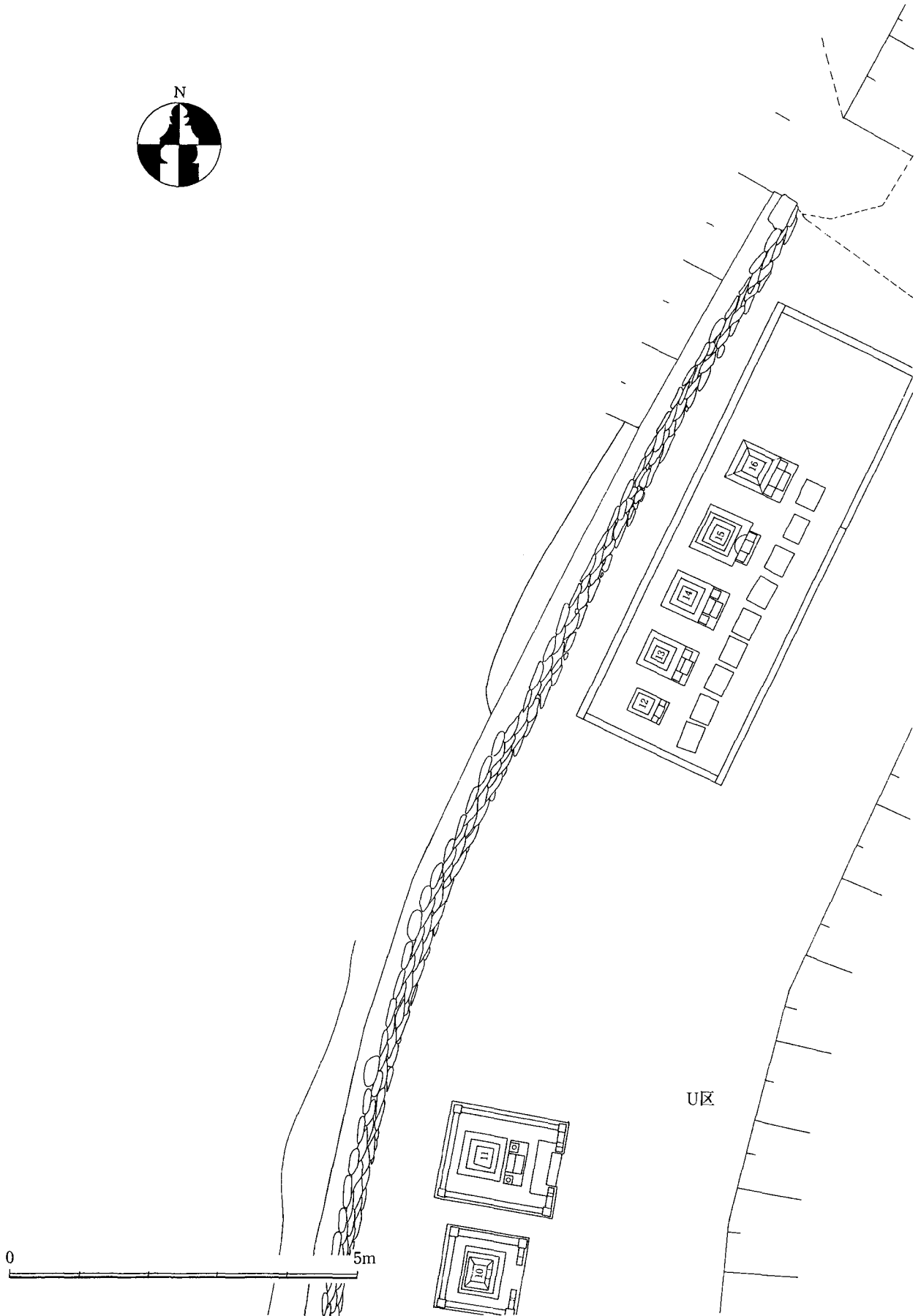

図版 22 ドサカ墓地 ③-(2)

図版 23 トサカ墓地 ㉔

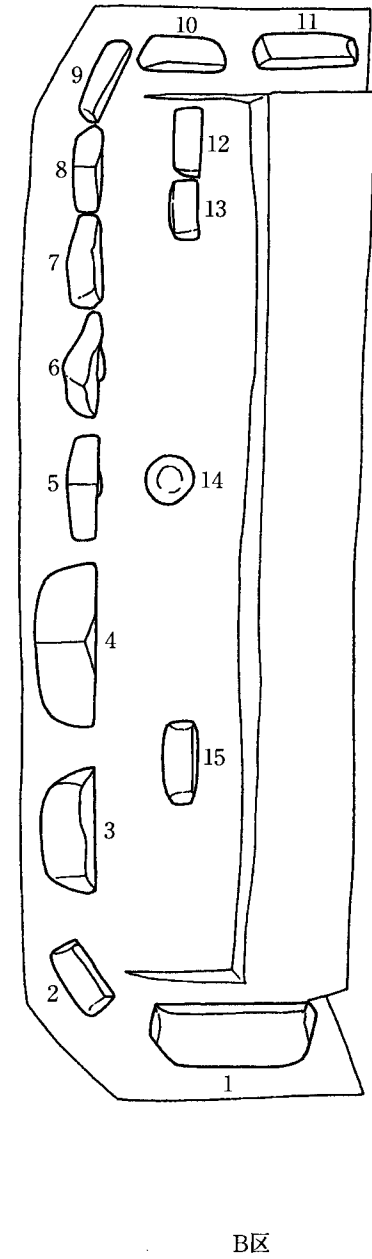
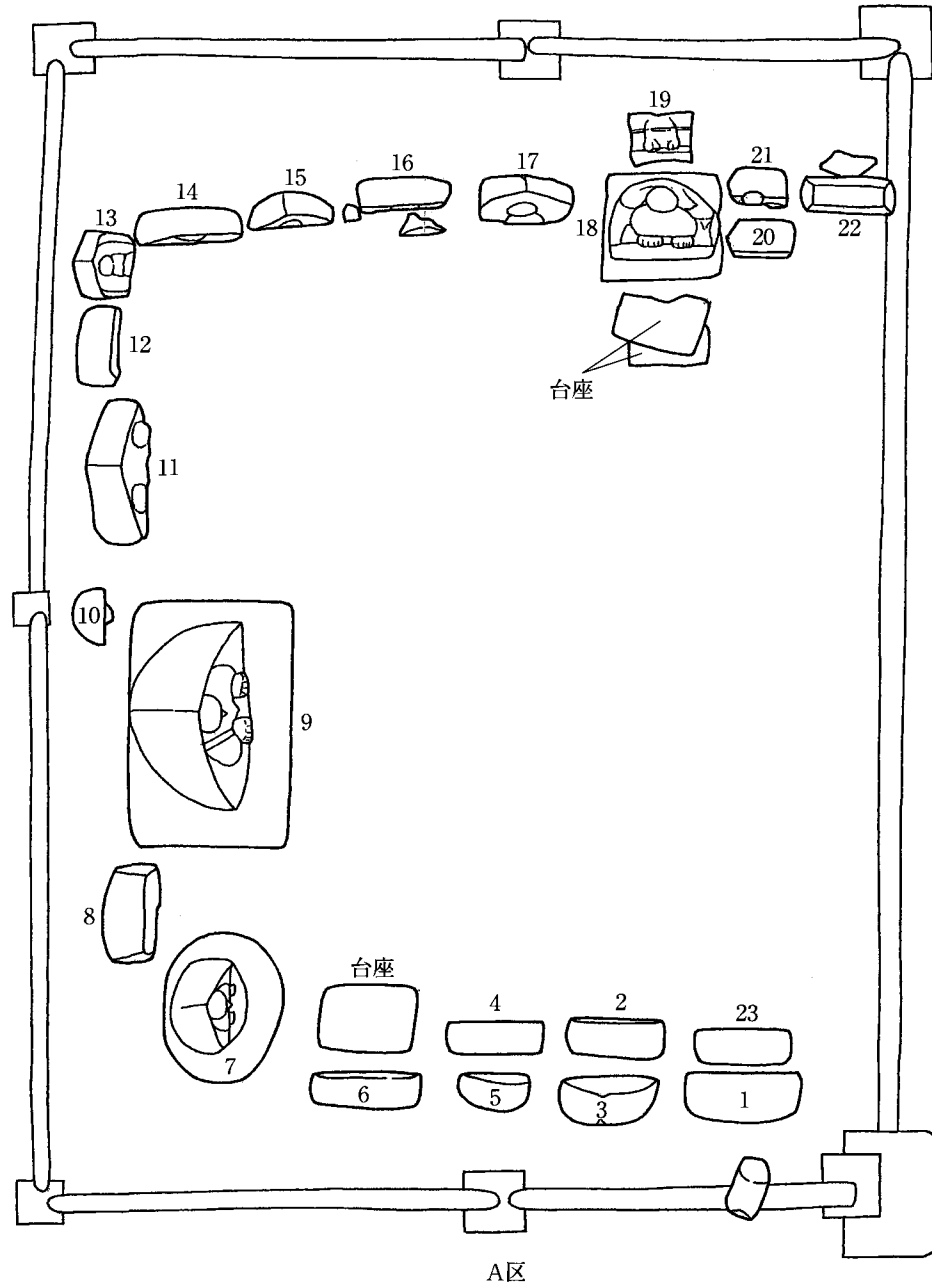

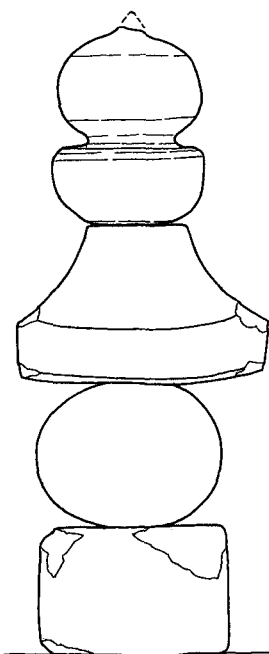

1 別石五輪塔 (C-20)

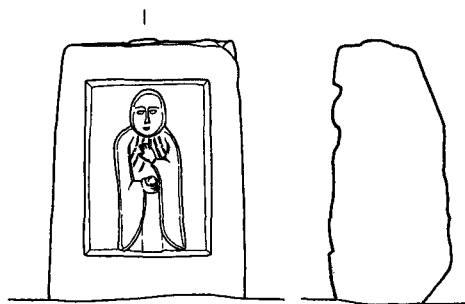

2 箱仏 (B-15)

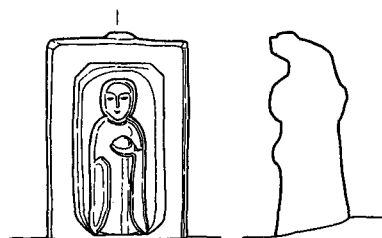

3 箱仏 (D-4)

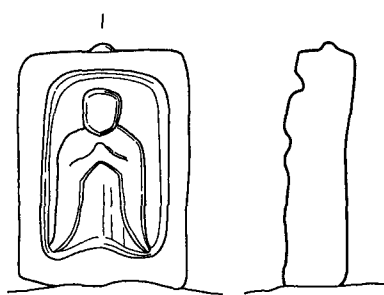

4 箱仏 (B-12)

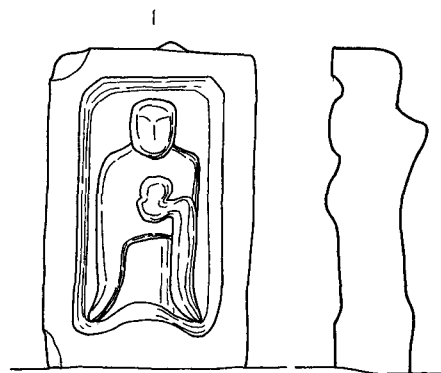

5 箱仏 (A-4)



6 別石五輪塔 (C-15)

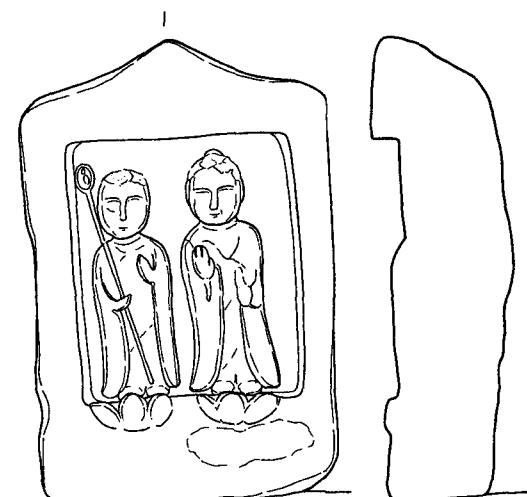

7 箱仏 (A-20)

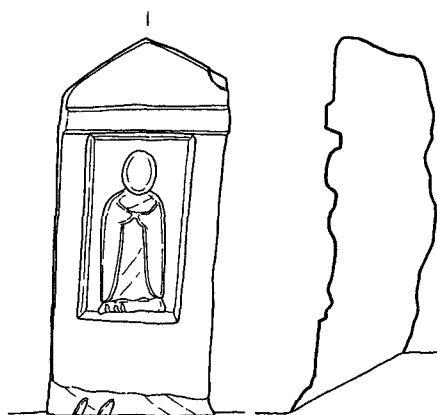

8 有像板碑形 (A-13)



9 箱仏 (D-4)

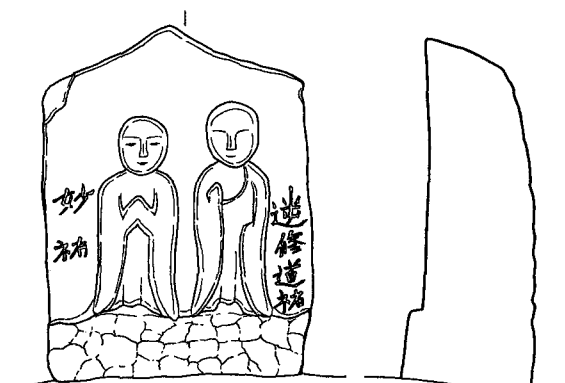

10 有像駒形 (B-5)

0 1/10 50cm

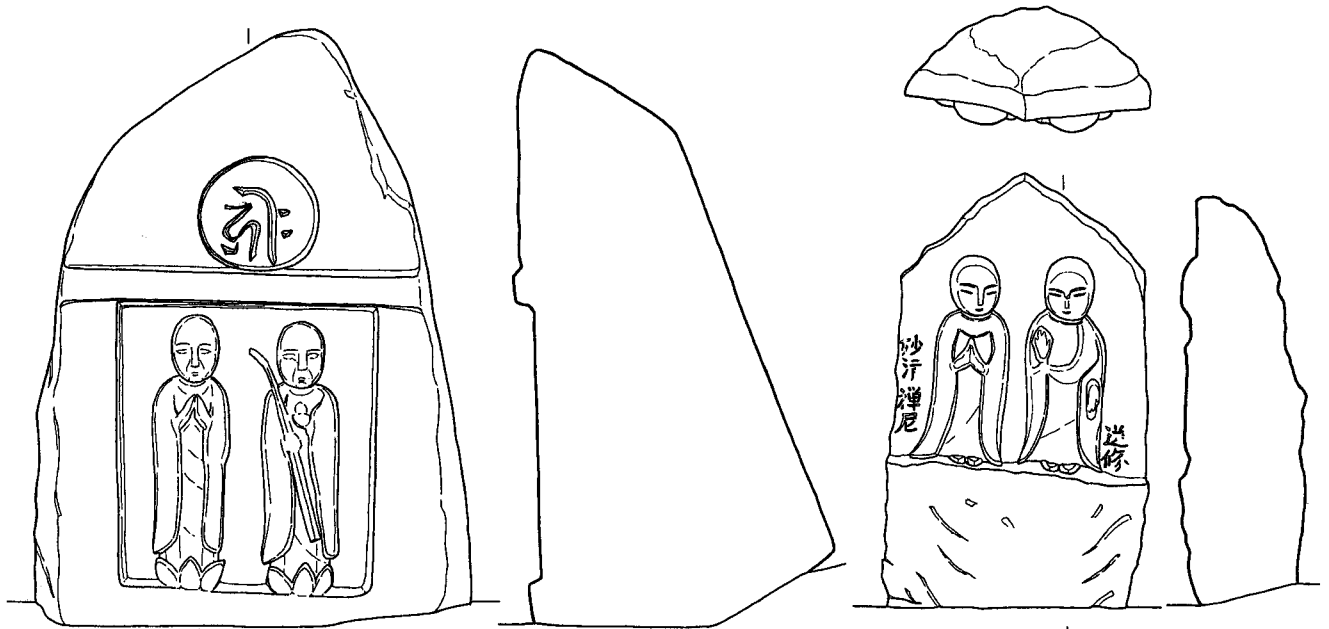

1 有像駒形 (C3)

2 有像舟形 (A-12)

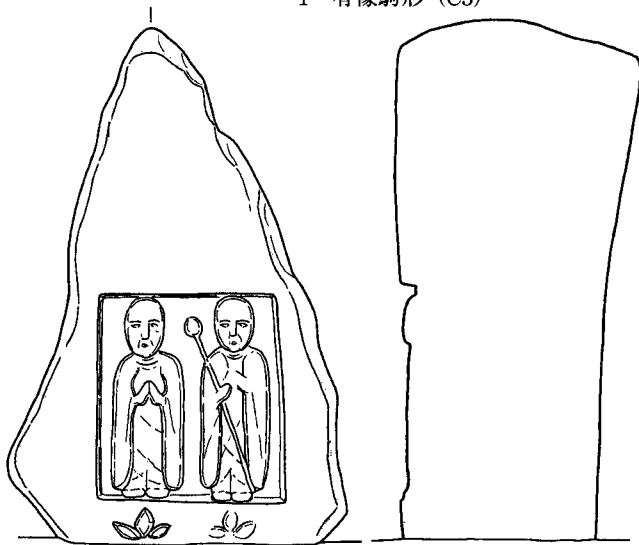

3 有像自然石 (C-2)

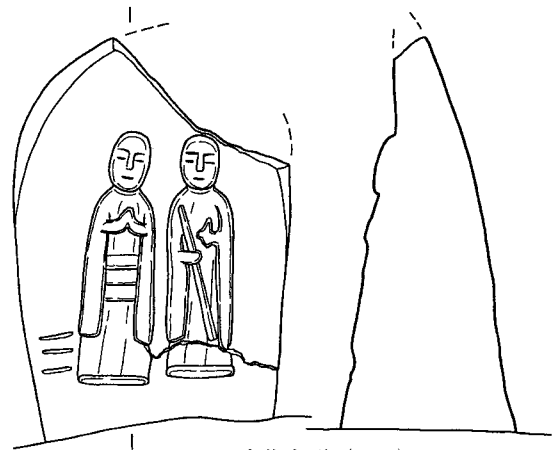

4 有像舟形 (B-6)

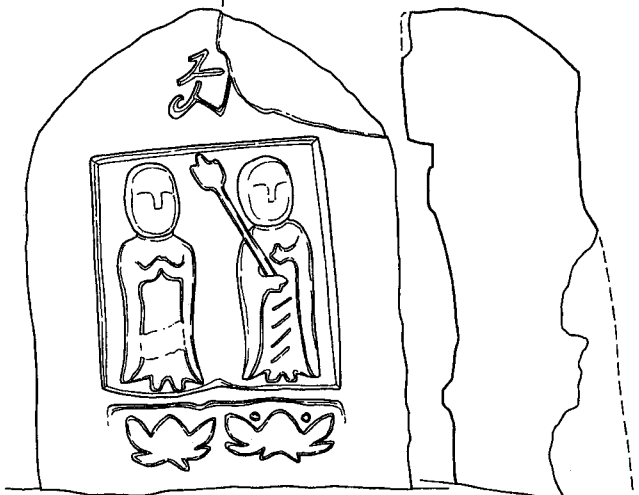

5 箱仏 (B-1)



6 有像板碑形 (B-4)

0 1/10 50cm

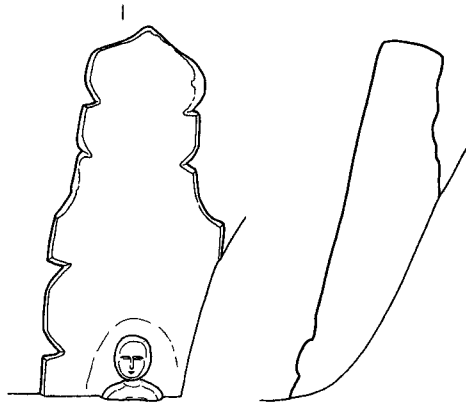

1 半截五輪塔 (Na-26)

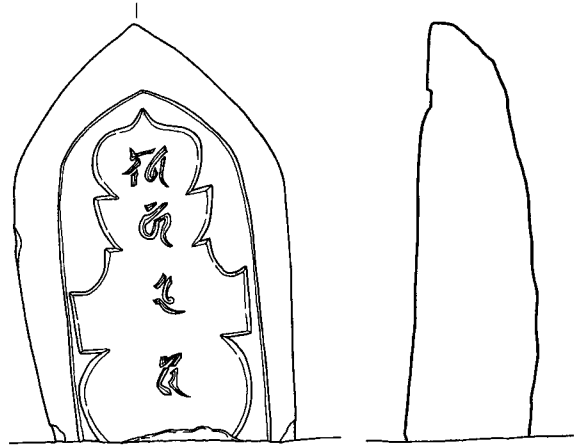

5 背光五輪塔 (A-3)



2 背光五輪塔 (B-10)

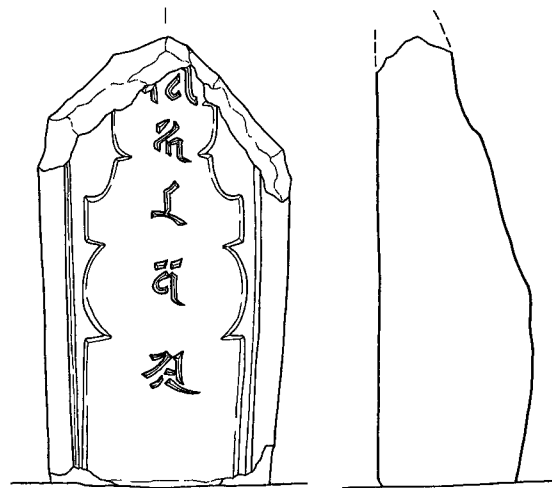

6 背光五輪塔 (D-29)

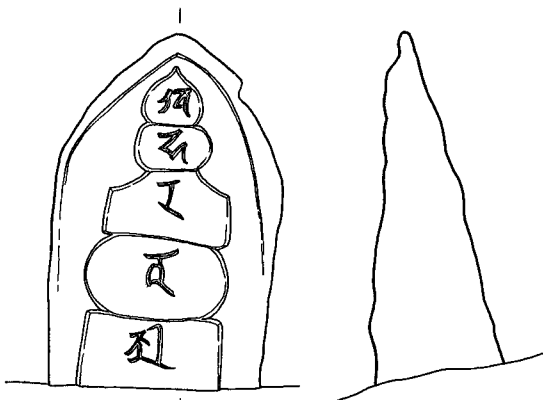

3 背光五輪塔 (B-7)

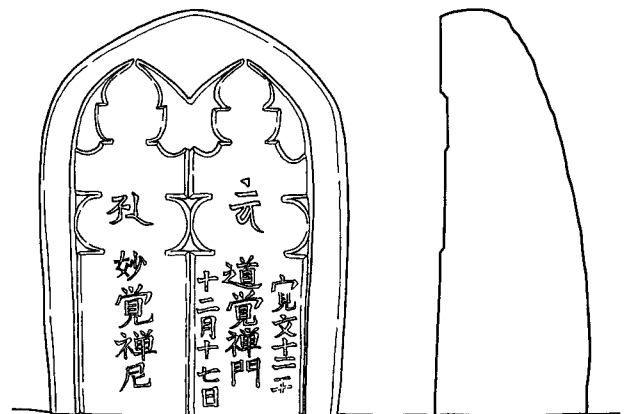

7 背光連立五輪塔 (D-24, 寛文十二年:1672)

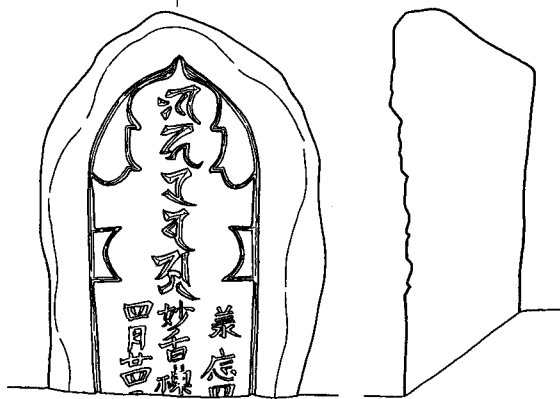

4 背光五輪塔 (D-21, 承応四年:1656)

0 1/10 50cm

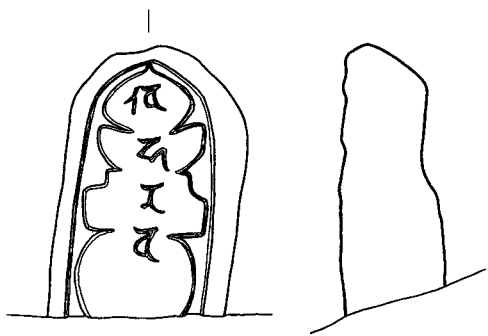

1 背光五輪塔 (B-9)

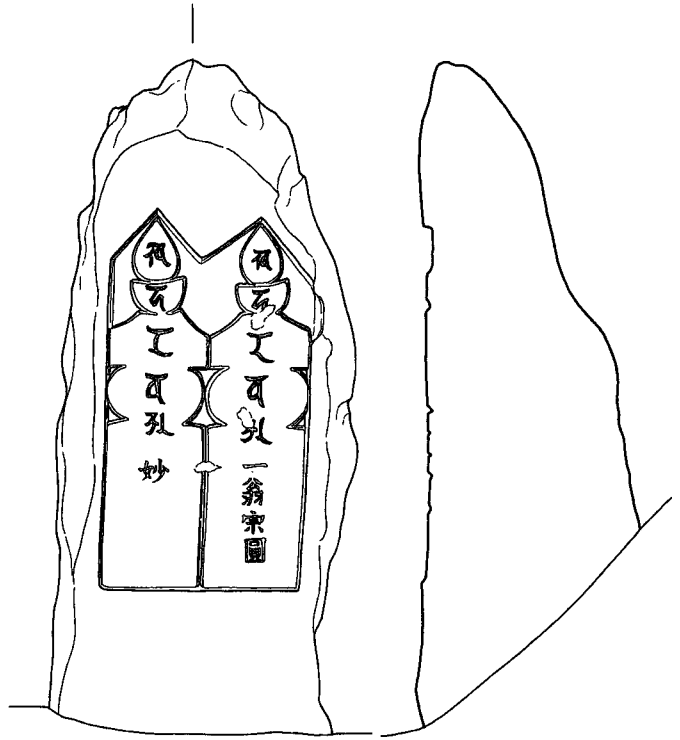

4 不定形連立五輪塔 (Nc-33)

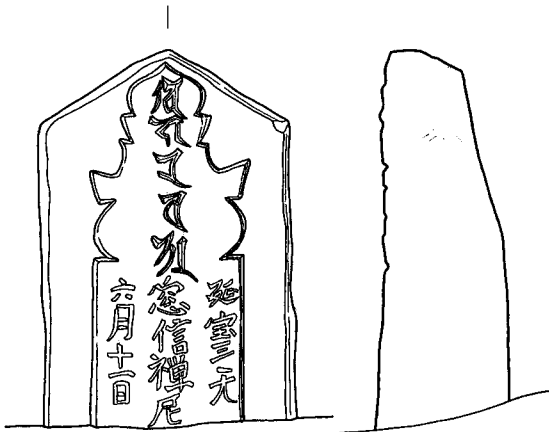

2 駒形五輪塔 (D-20, 延宝三年:1675)

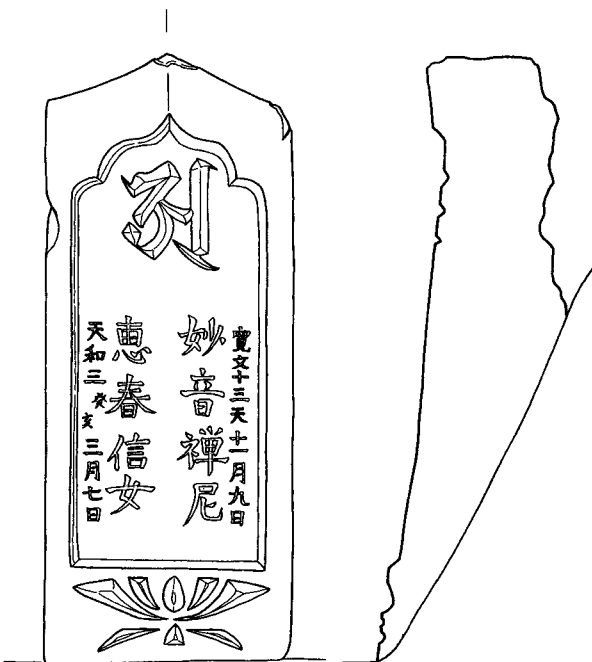

3 駒形 (F-3, 天和三年:1683)

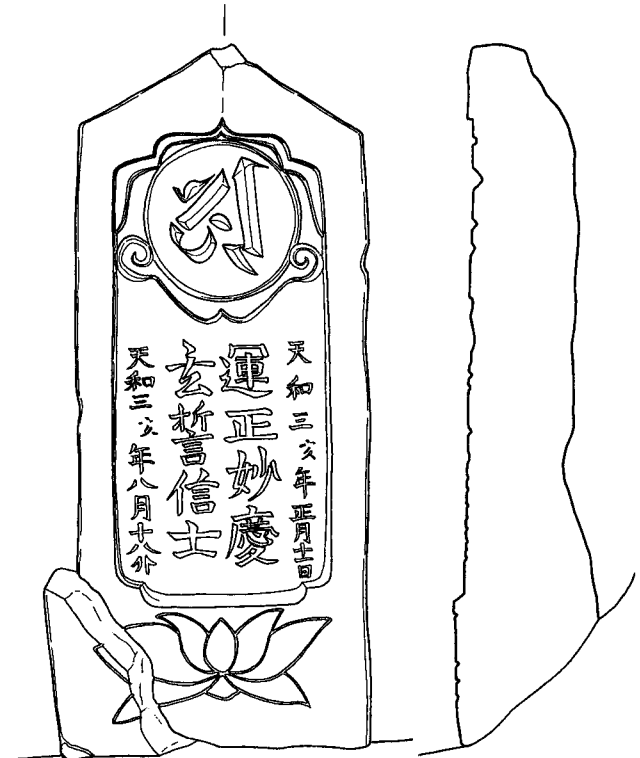

5 駒形 (L-7, 天和三年:1683)

0 1/10 50cm

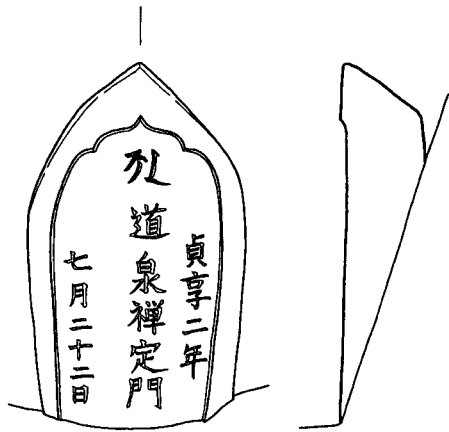

1 舟形 (Ra-9, 貞享二年：1685)

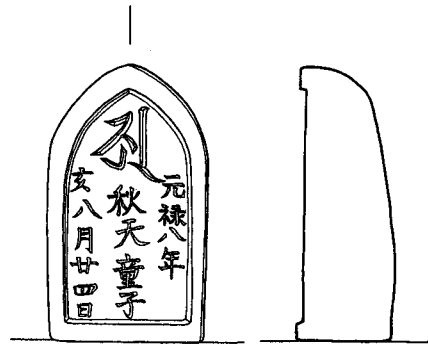

2 舟形 (Q-25, 元禄八年：1695)

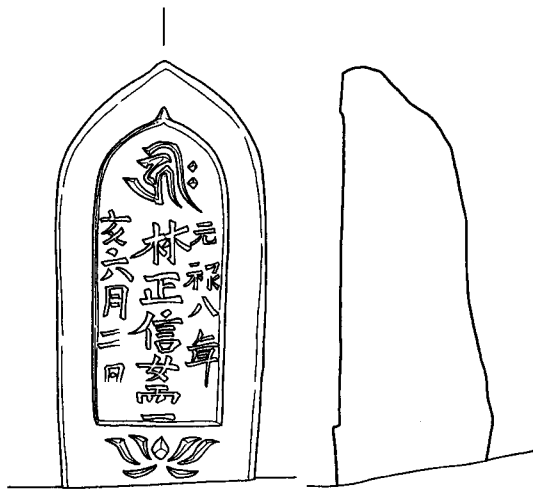

3 舟形 (D-26, 元禄八年：1695)

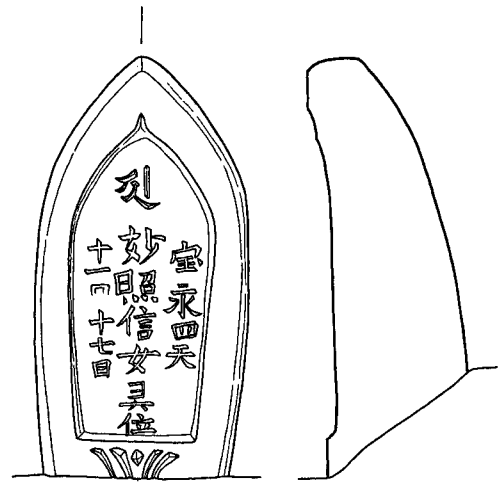

4 舟形 (D-25, 宝永四年：1707)

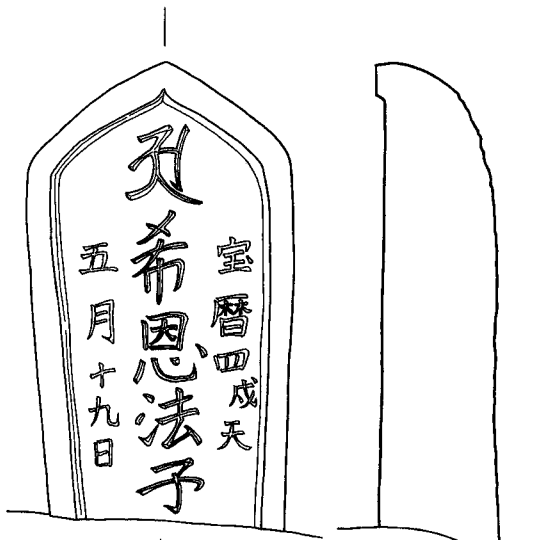

5 舟形 (B-3, 宝曆四年：1754)

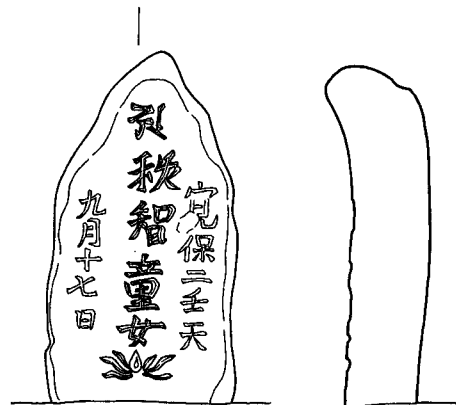

6 舟形 (D-8, 宽保二年：1742)

0 1/10 50cm

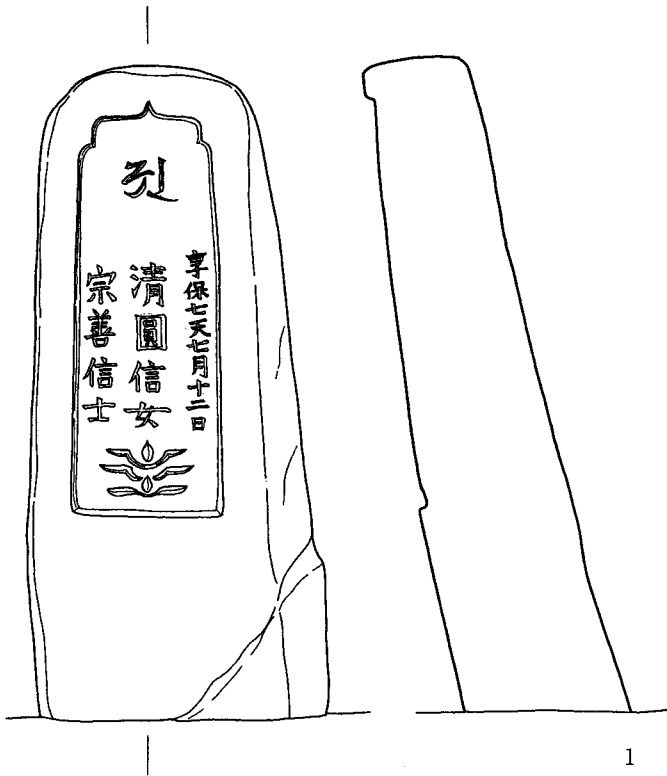

1

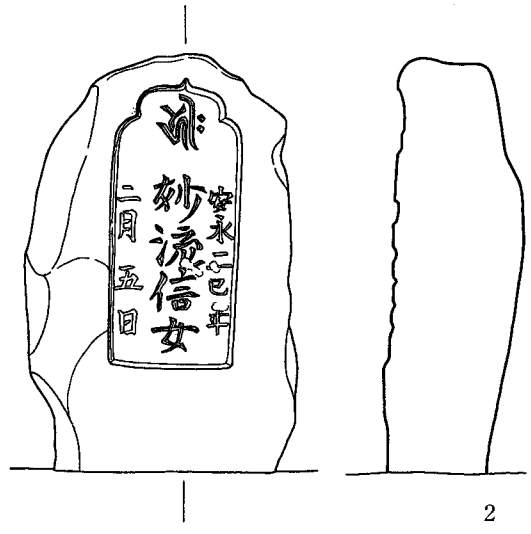

2

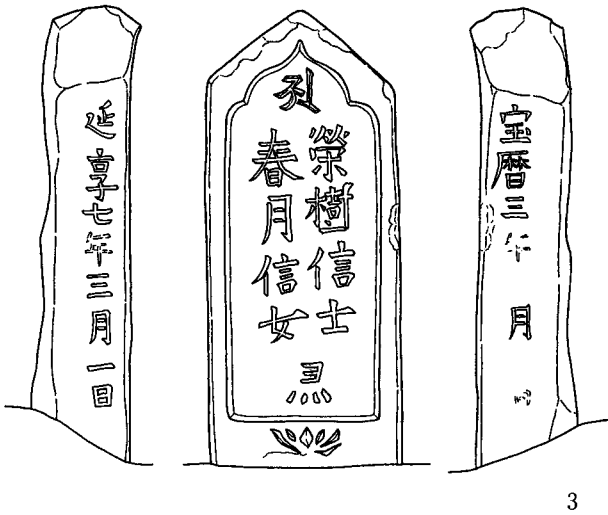

3

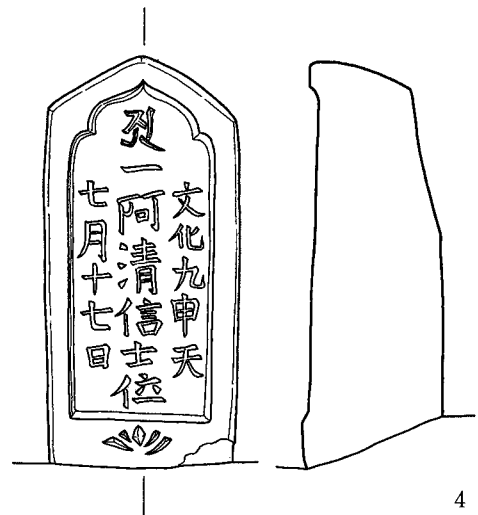

4

- 1 櫛形 (C-4, 享保七年：1722)
- 2 自然石 (D-19, 安永二年：1773)
- 3 駒形 (D-28, 宝曆三年：1753)
- 4 駒形 (D-27, 文化九年：1812)

0 1/10 50cm

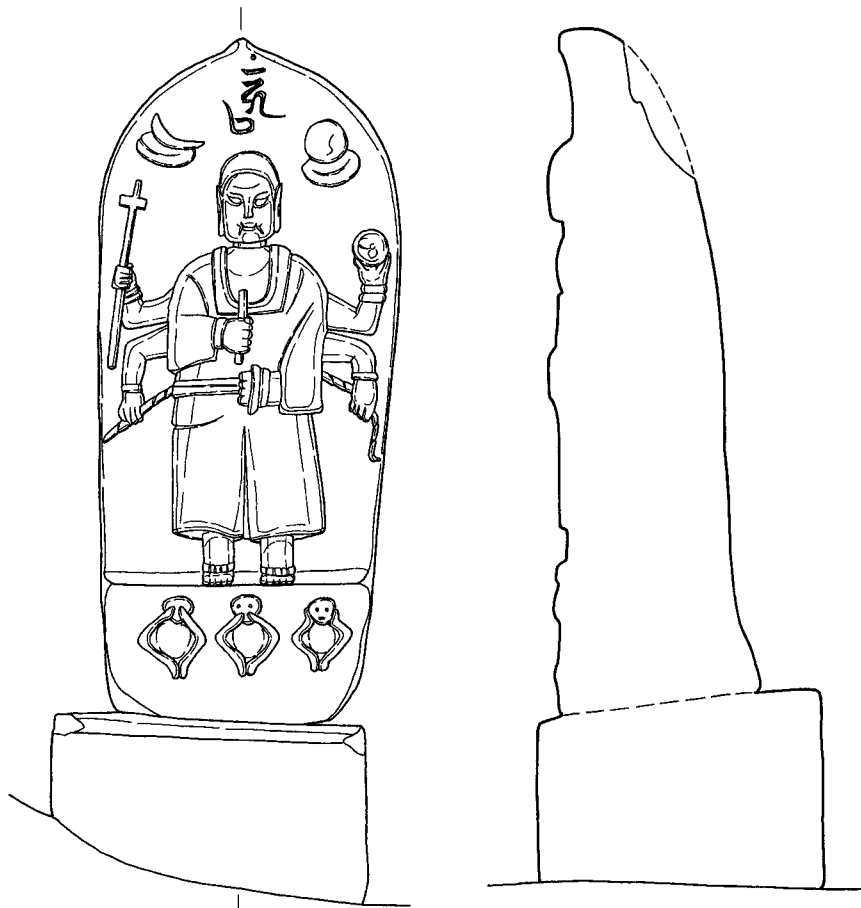

1 有像舟形 (A-18)

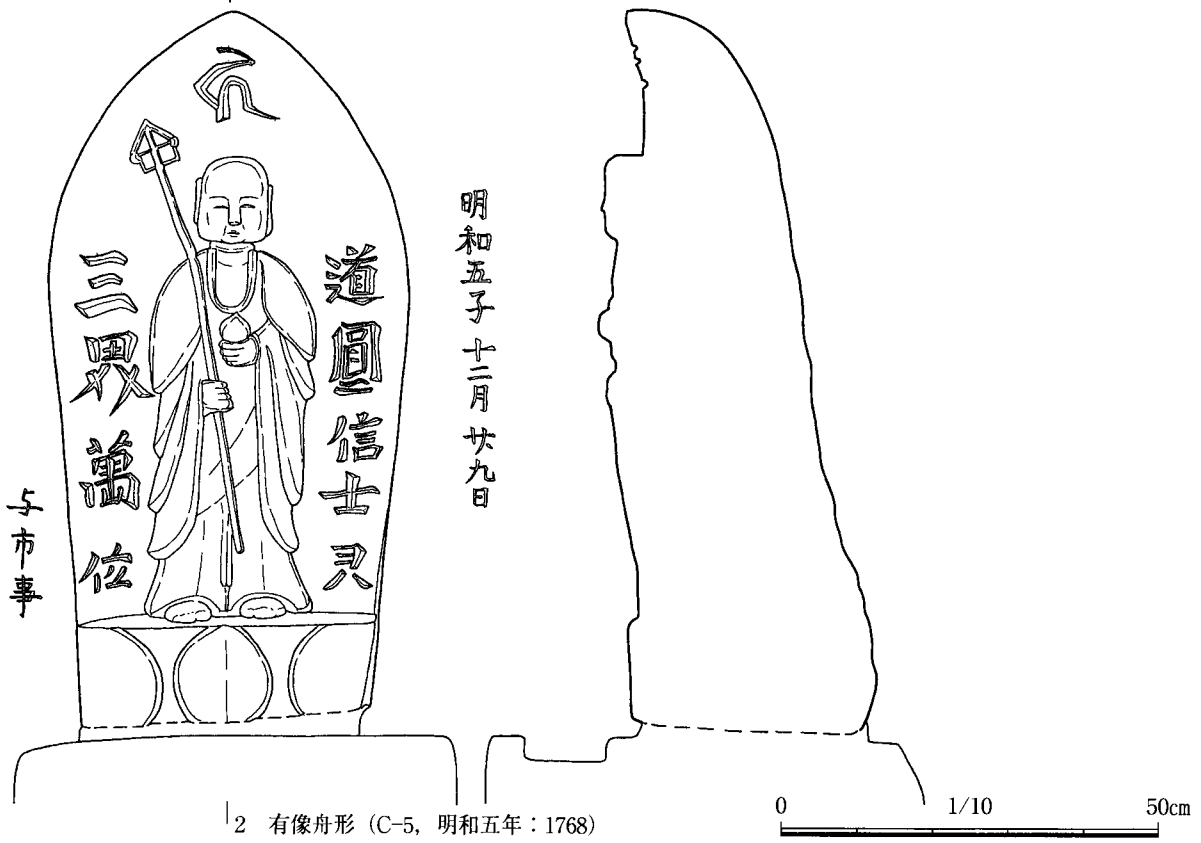

2 有像舟形 (C-5, 明和五年: 1768)

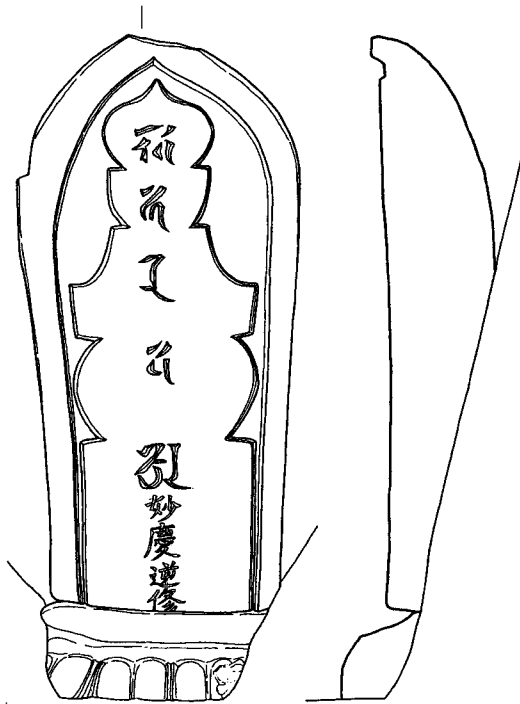

1 背光五輪塔 (区画外)

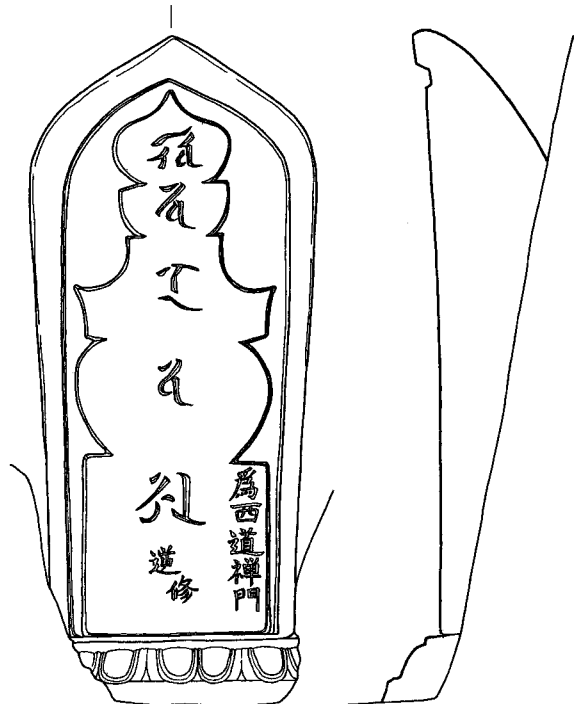

2 背光五輪塔 (区画外)



3 有像舟形 (A-9, 永祿三年：1560)

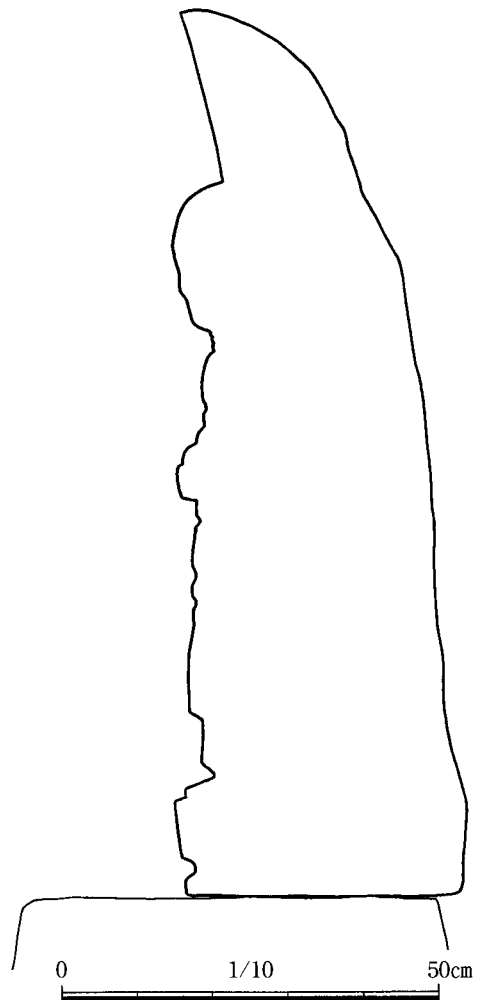

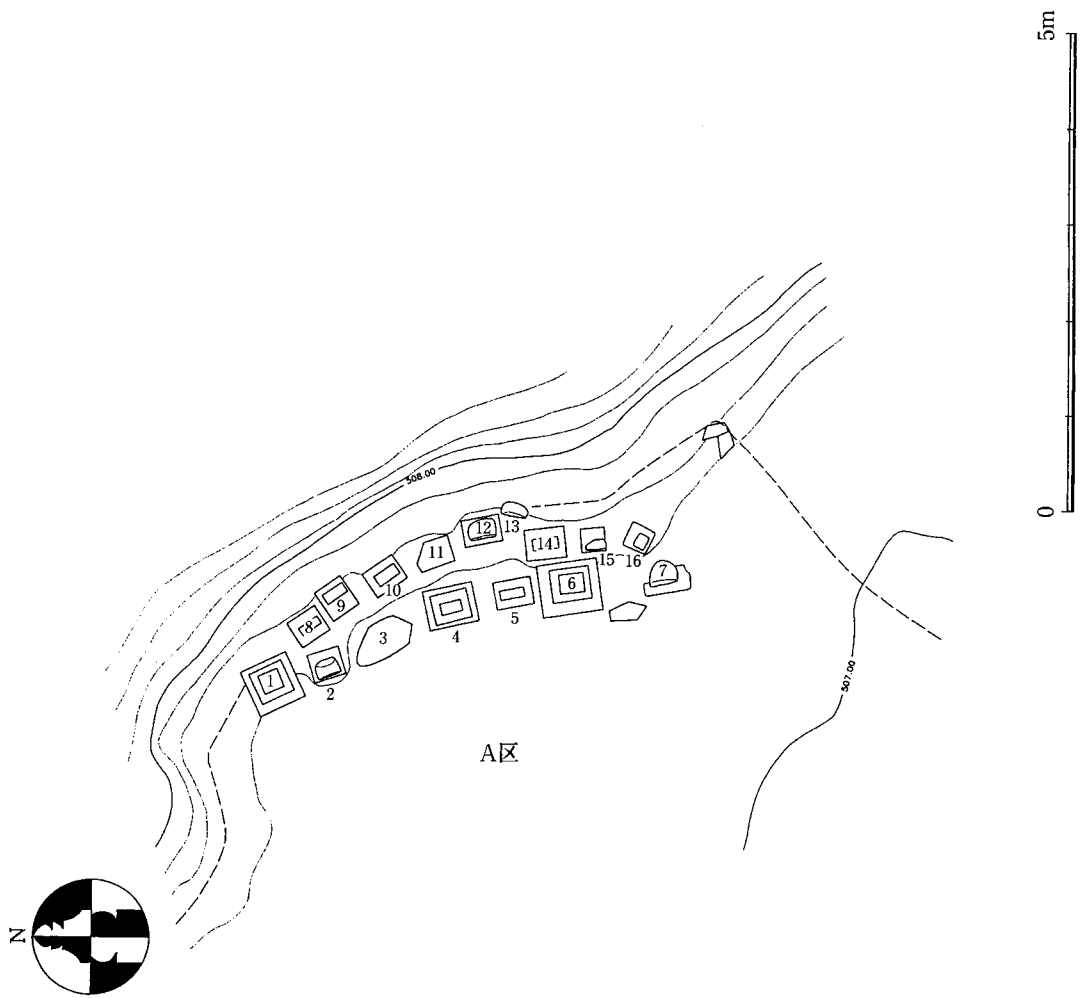

图版 32 春明院墓地 ①

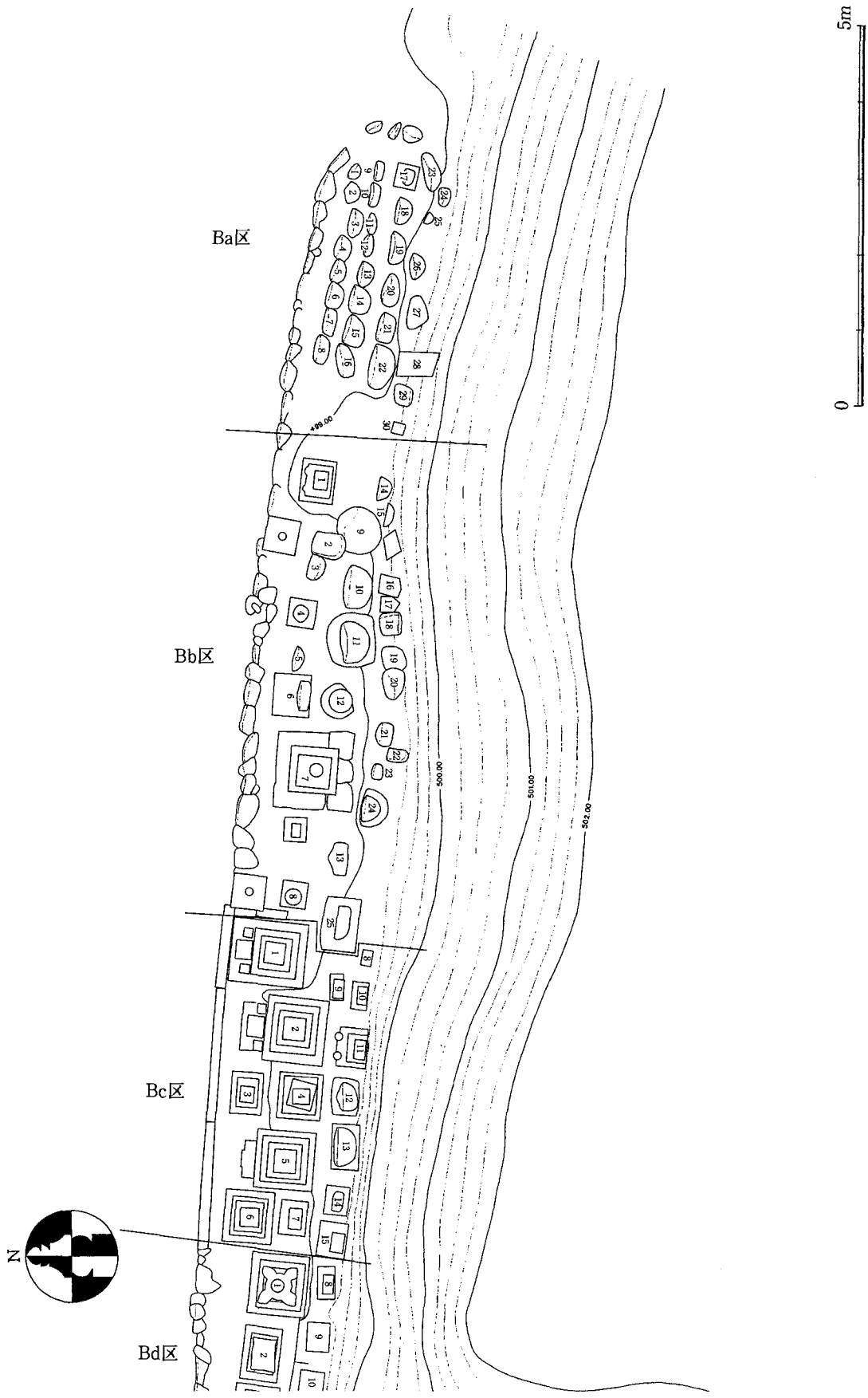

图版 33 春明院墓地 ②-1



图版 34 春明院墓地 ②-(2)

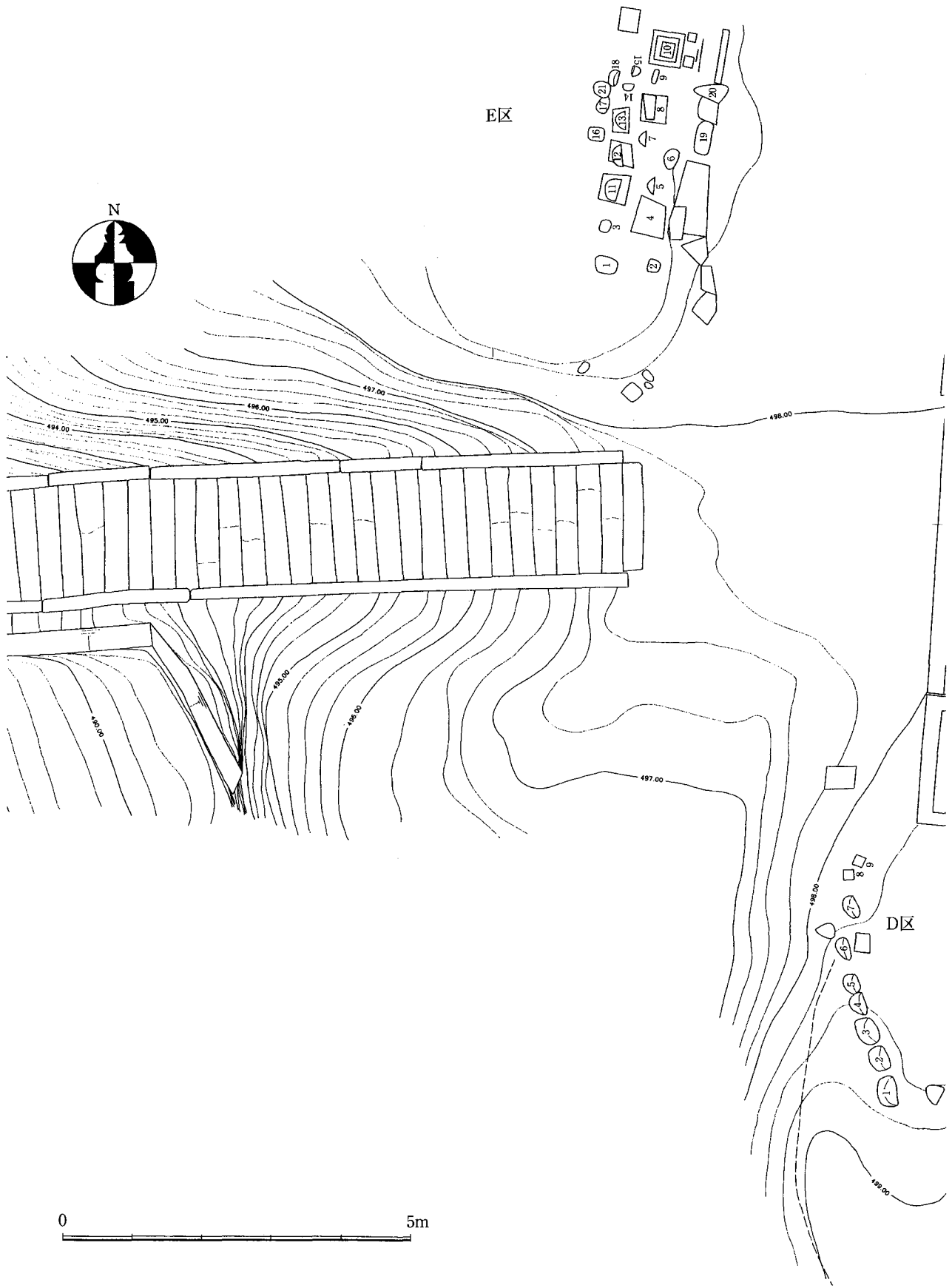

图版 35 春明院墓地 ③-1)

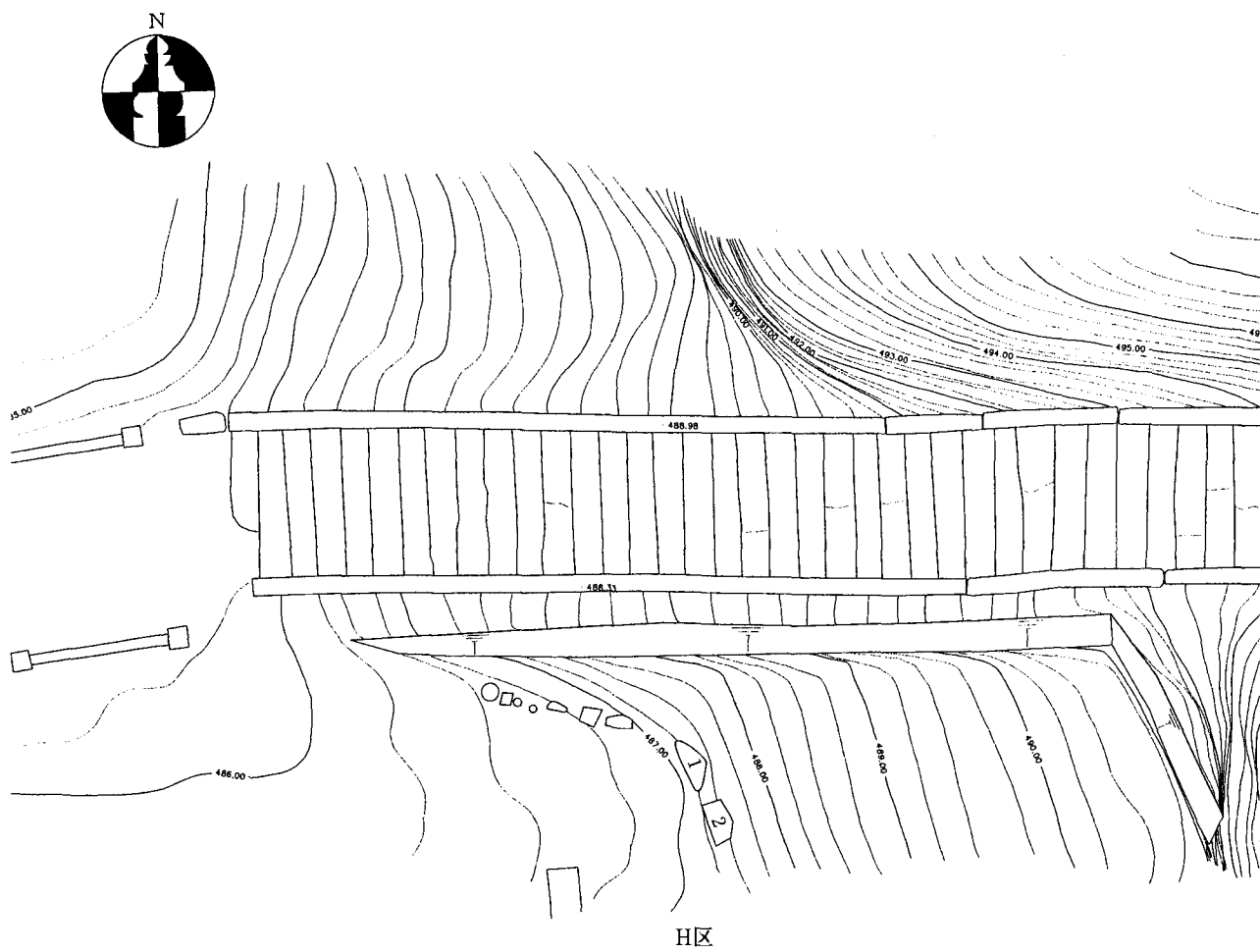

图版 36 春明院墓地 ③-(2)

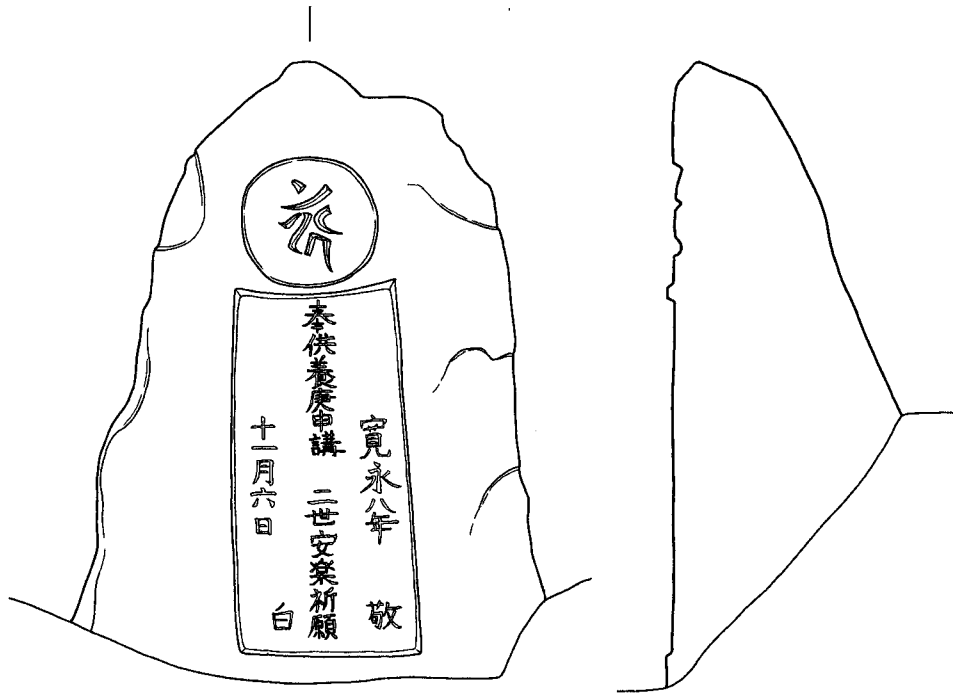

1 自然石 (寛永八年：1631)

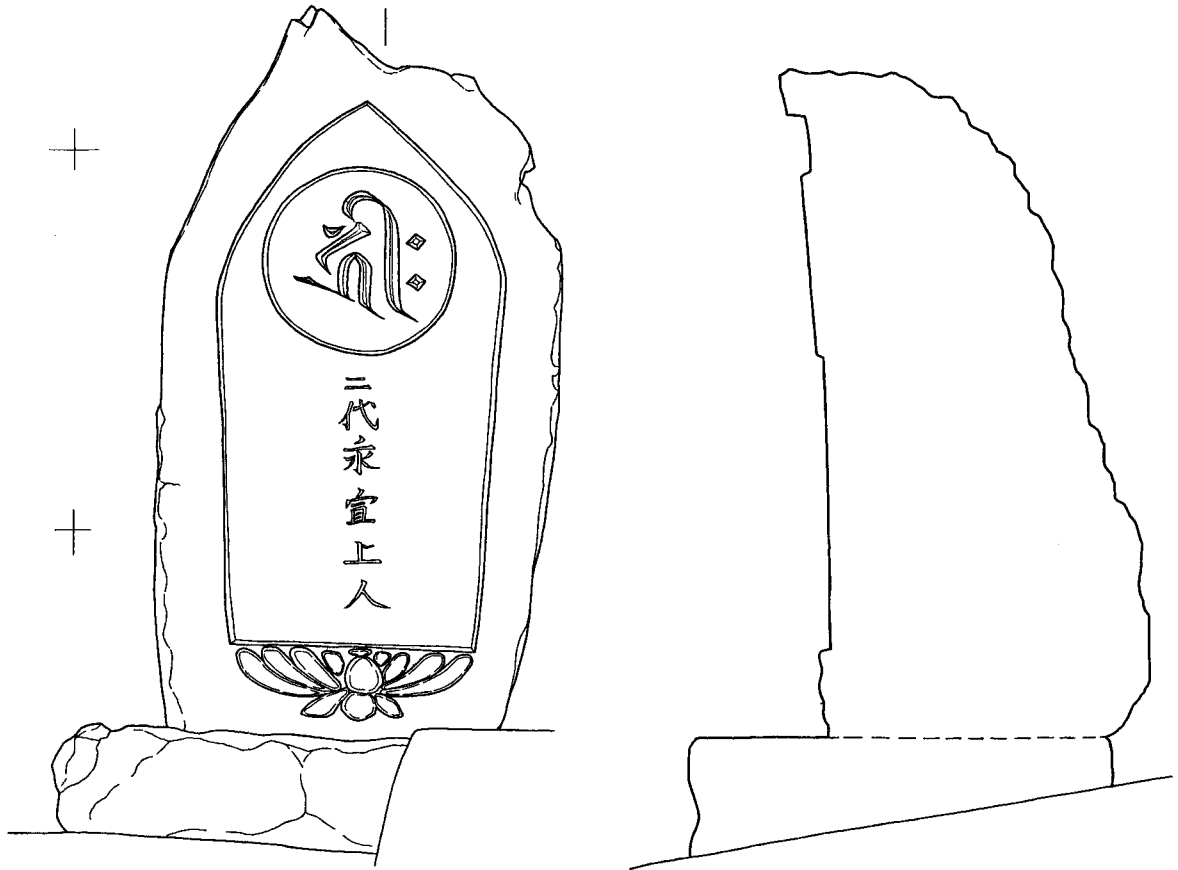

2 自然石 (Bb-9)

0 1/10 50cm

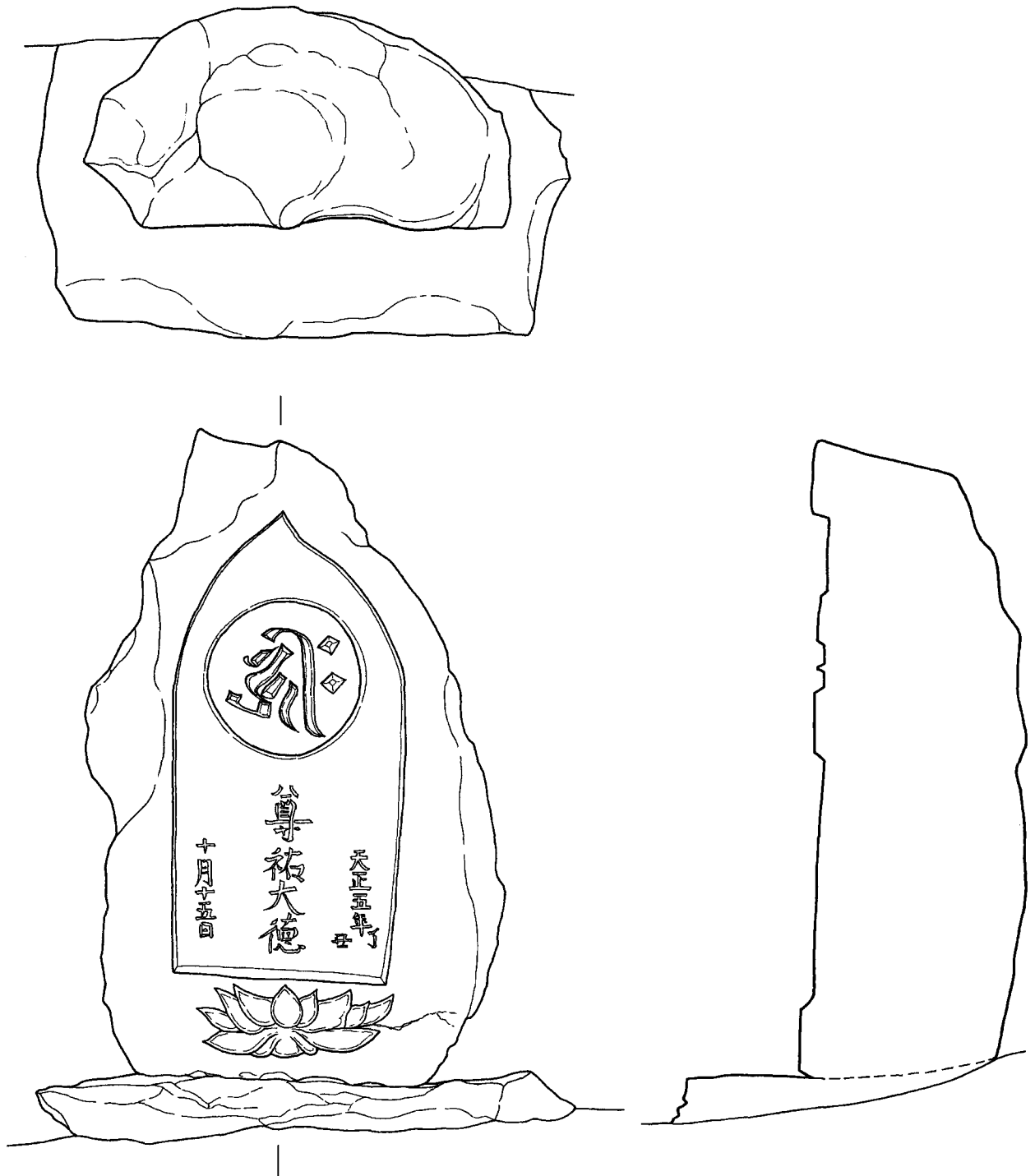

1 自然石 (Bb-11, 天正五年: 1577)

0 1/10 50cm

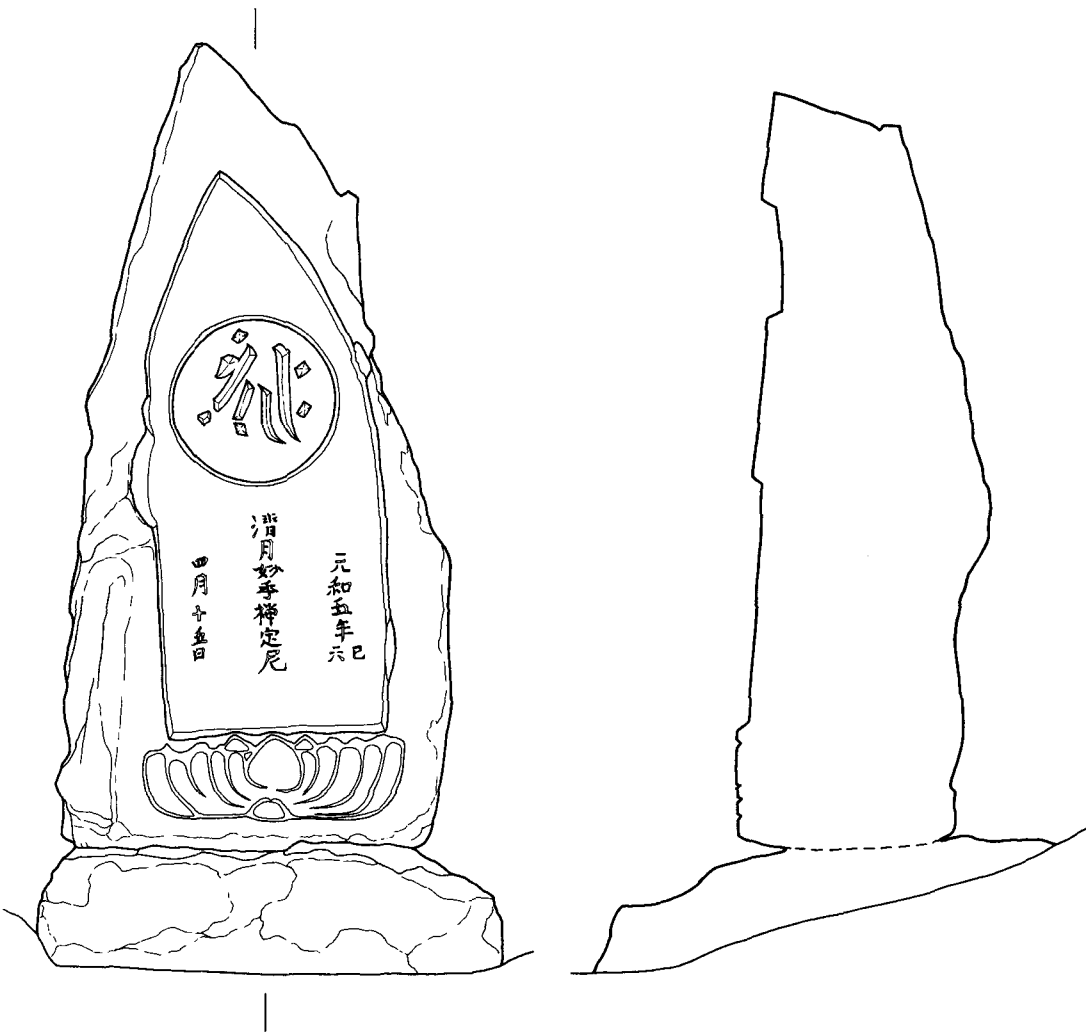
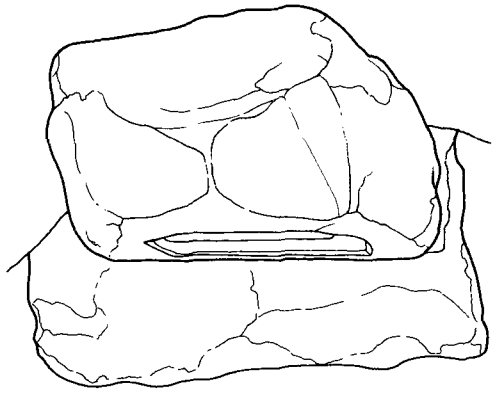

1 自然石 (Bb-10, 元和五年:1619)

0 1/10 50cm

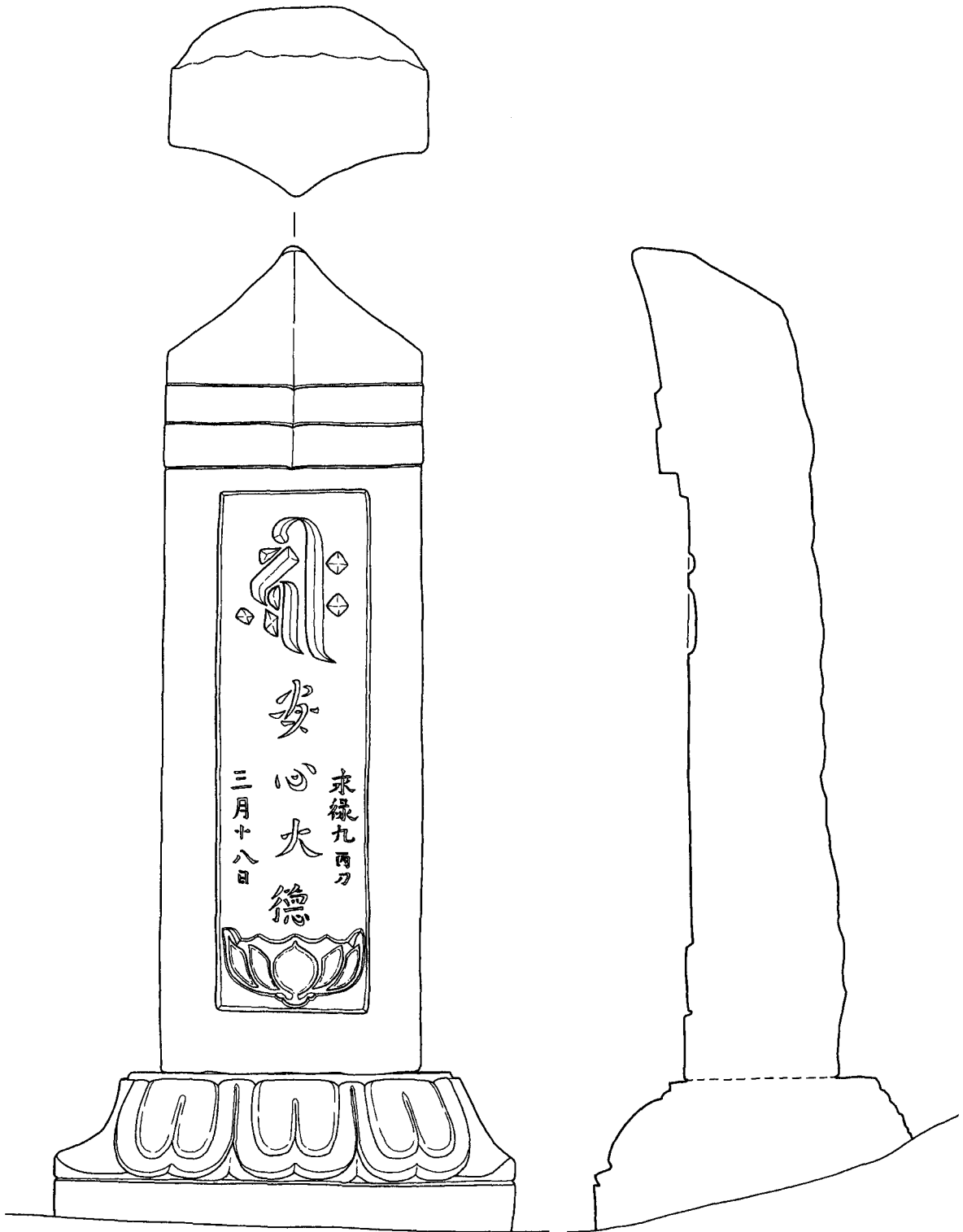

1 板碑形 (Bb-13, 永禄九年: 1566)

0 1/10 50cm



1 有像自然石 (E-5)

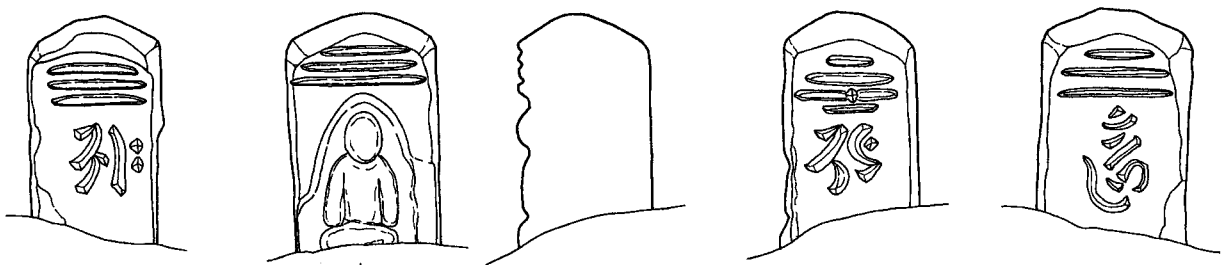

2 尖頭角柱 (E-17)

0 1/10 50cm

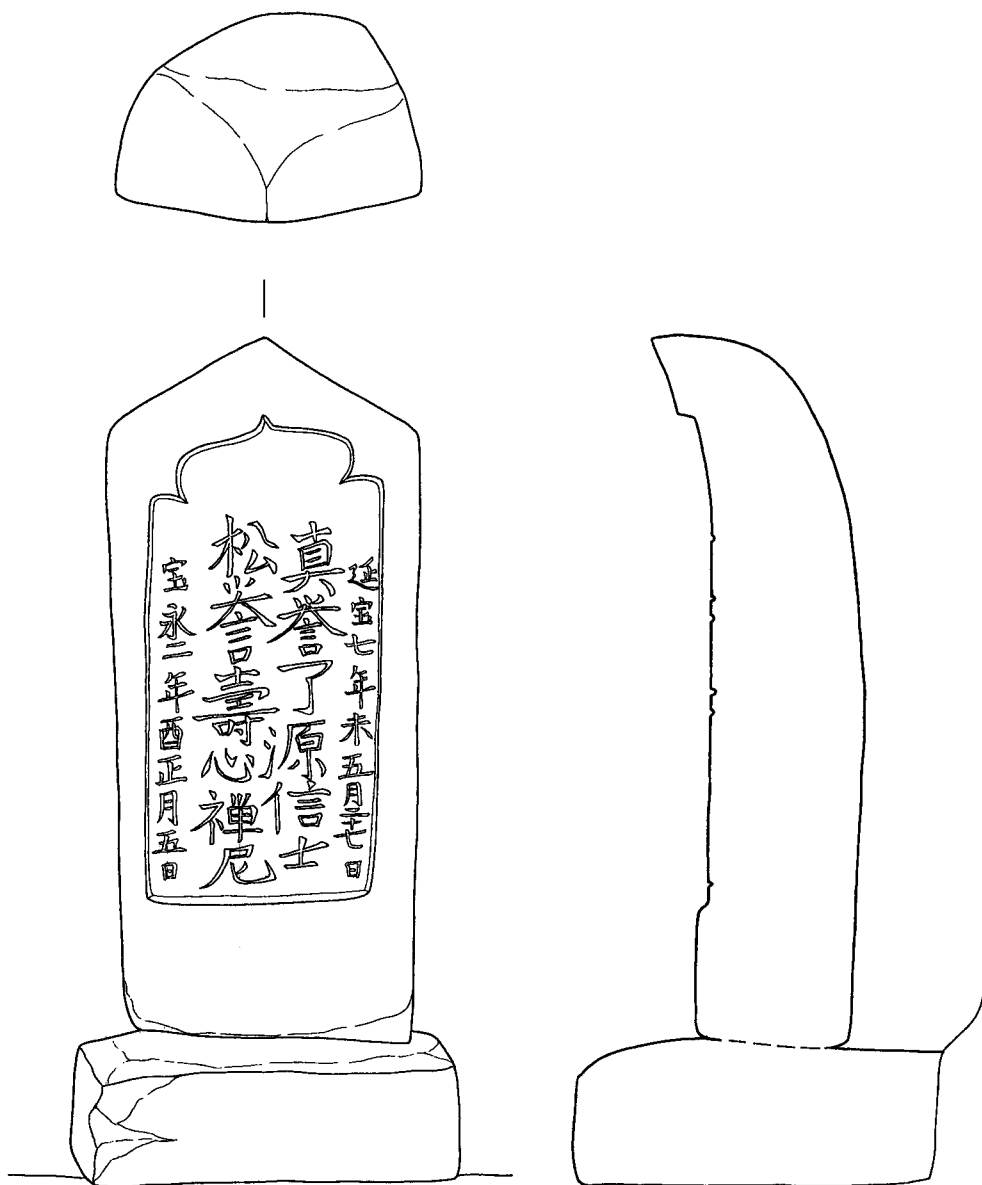

1 櫛形 (Bc-12, 宝永二年：1705)

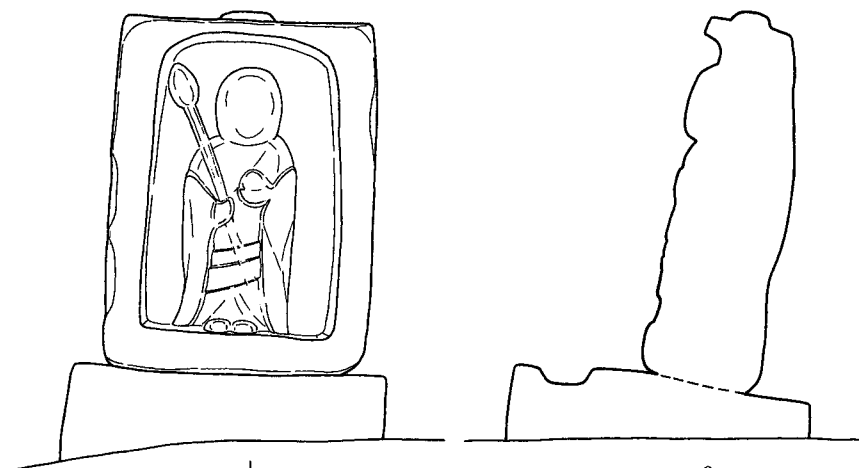

2 箱仏 (E-9)

0 1/10 50cm

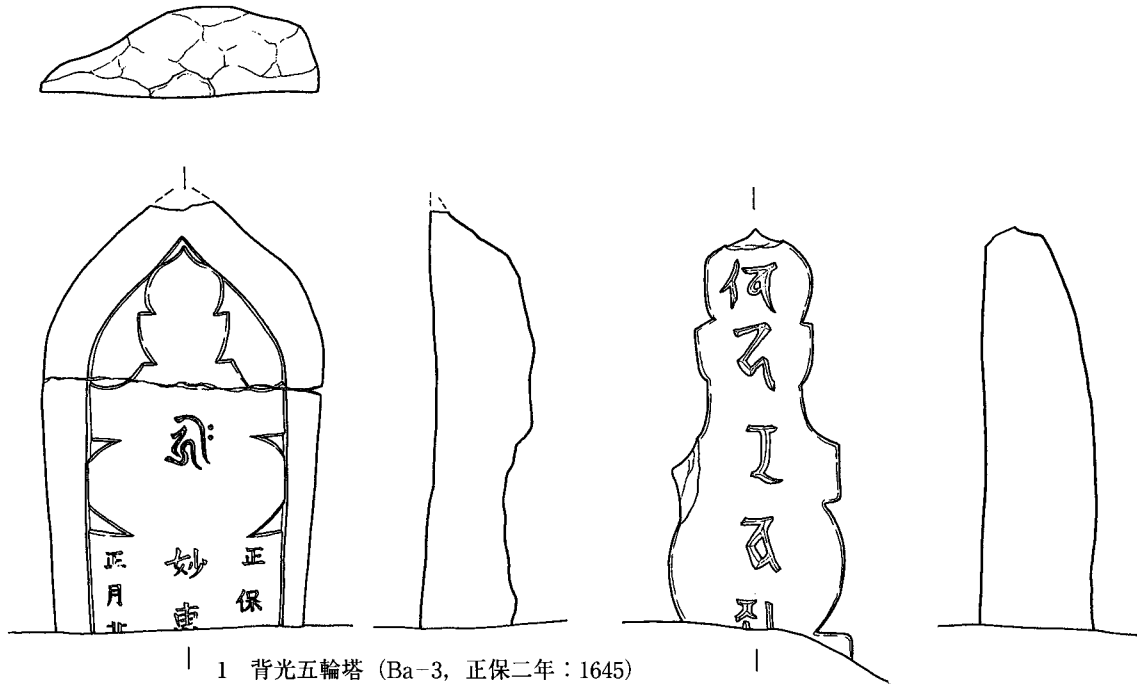

1 背光五輪塔 (Ba-3, 正保二年: 1645)

2 半截五輪塔 (E-2)

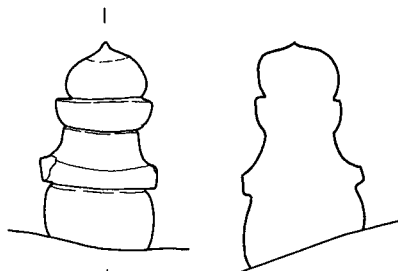

3 一石五輪塔 (E-3)

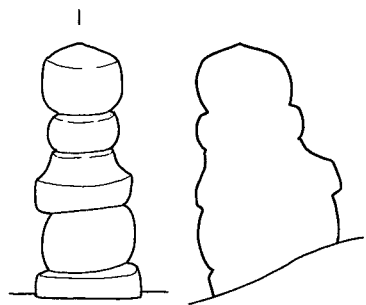

4 一石五輪塔 (D-8)

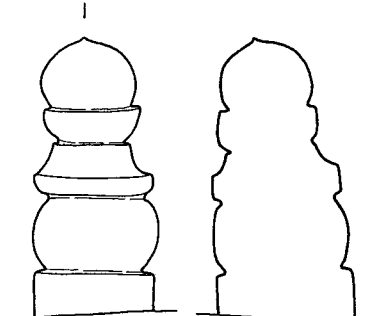

5 一石五輪塔 (E-15)

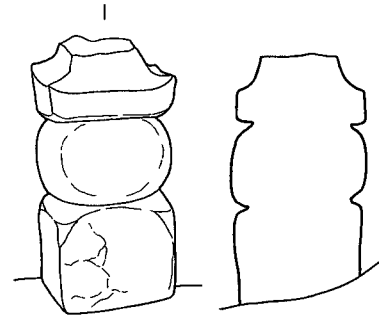

6 一石五輪塔 (Bb-22)

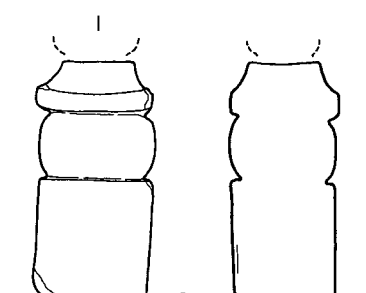

7 一石五輪塔 (庫裏前)

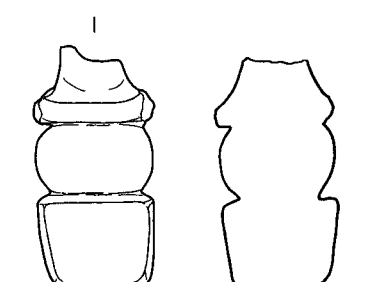

8 一石五輪塔 (本堂裏)

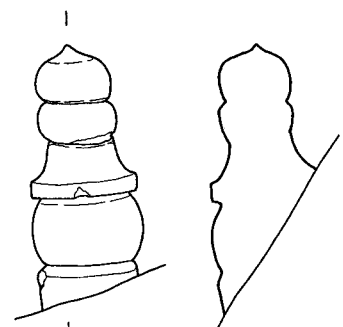

9 一石五輪塔 (D-9)

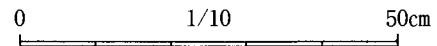

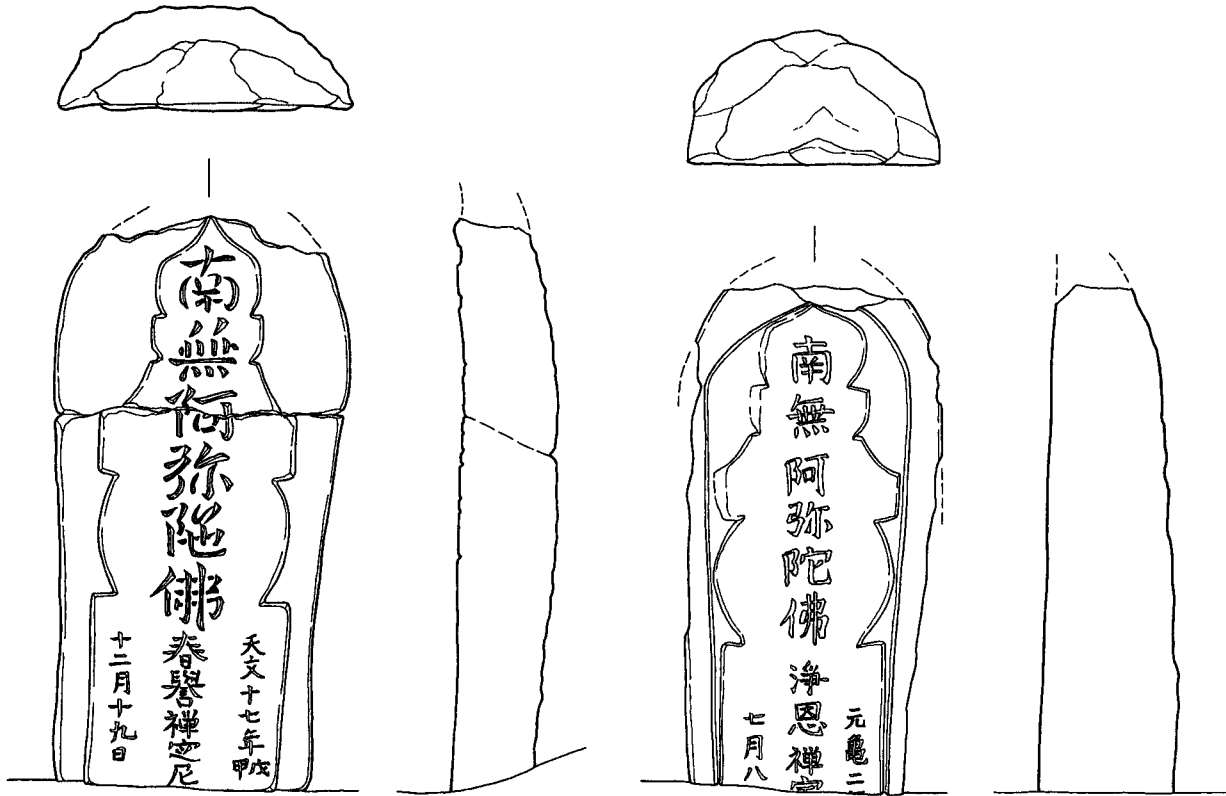

1 背光五輪塔 (Bb-2, 天文十七年：1548)

2 背光五輪塔 (Bb-5, 元龜二年：1571)



3 背光五輪塔 (Ba-8, 寛永三年：1626)

4 背光五輪塔 (Ba-7, 正保三年：1646)

0 1/10 50cm

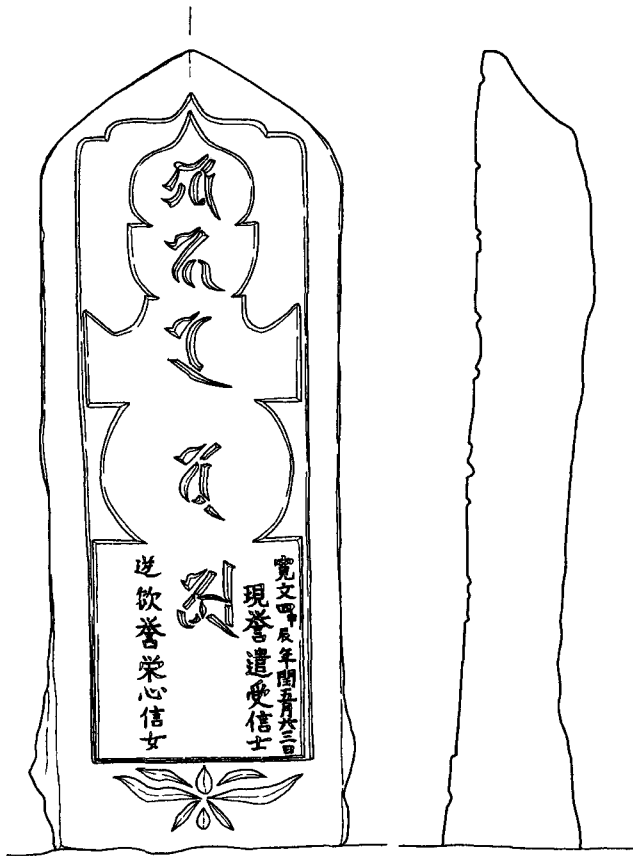

1 背光五輪塔 (Bb-6, 寛文四年：1664)

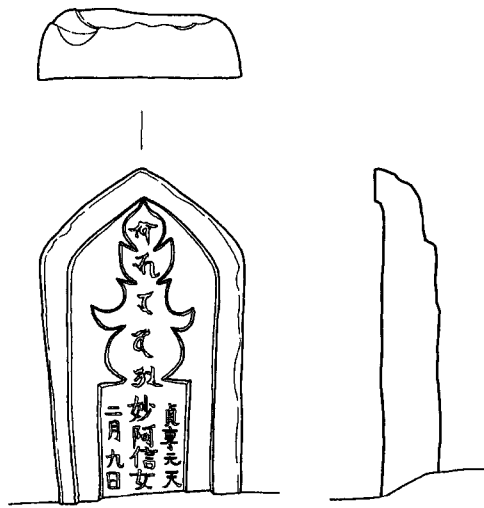

2 背光五輪塔 (Ba-9, 貞享元年：1684)

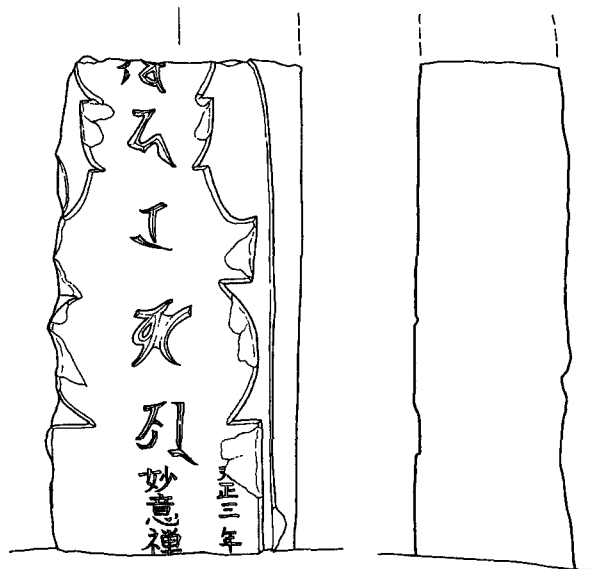

3 背光五輪塔 (Ba-18, 天正三年：1575)

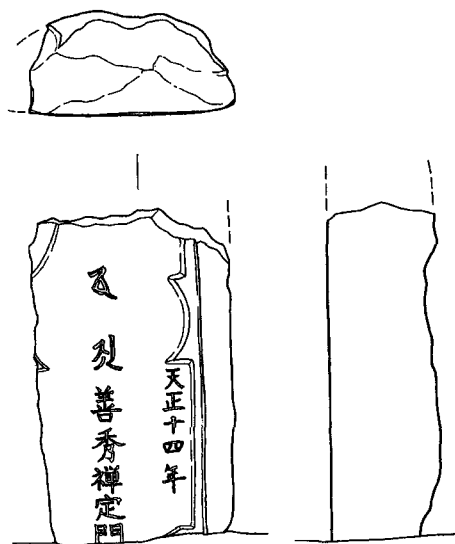

4 背光五輪塔 (Ba-29, 天正十四年：1586)

0 1/10 50cm

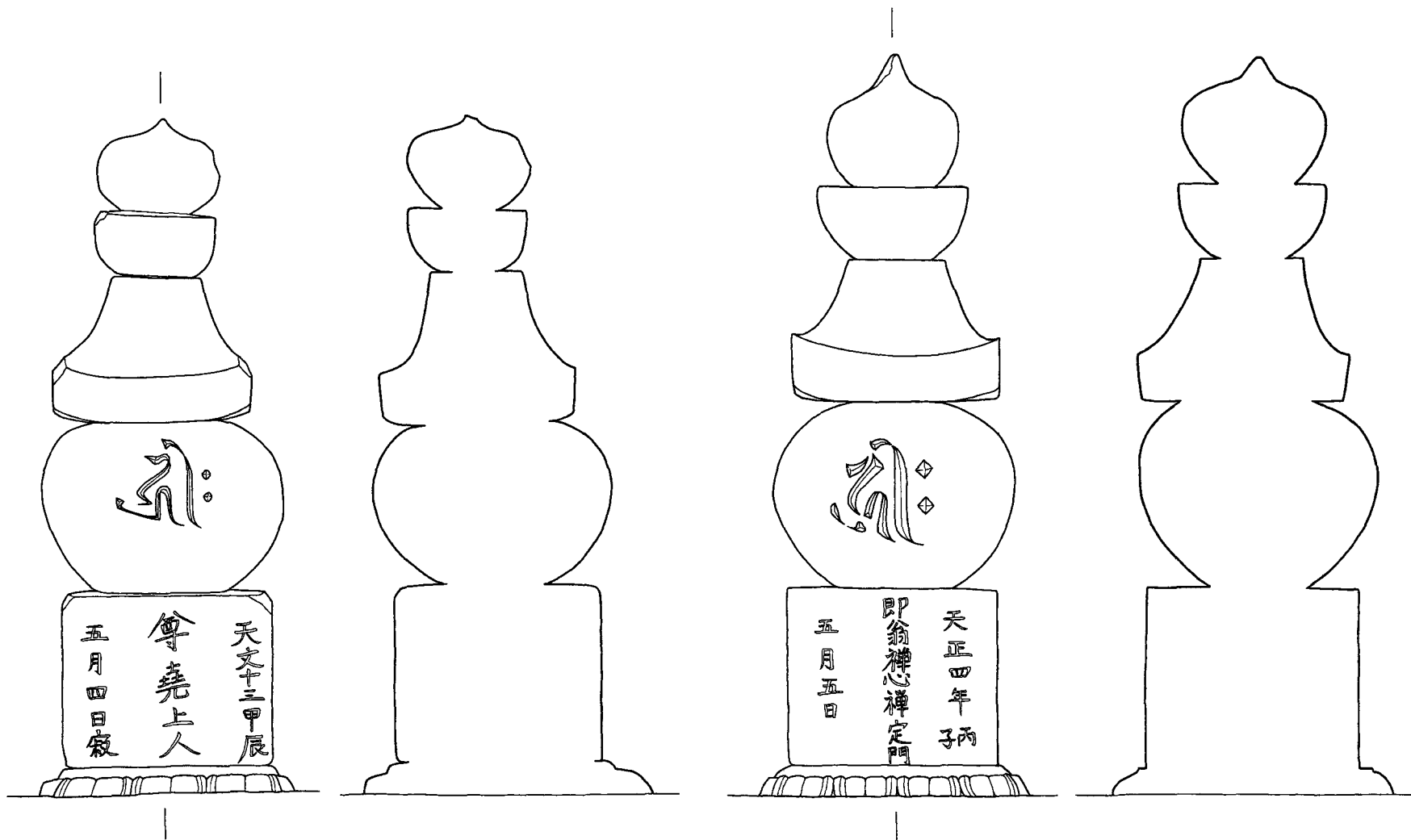

1 別石五輪塔 (Bb-4, 天文十三年：1544)

2 別石五輪塔 (Bb-8, 天正四年：1576)

0 1/10 50cm

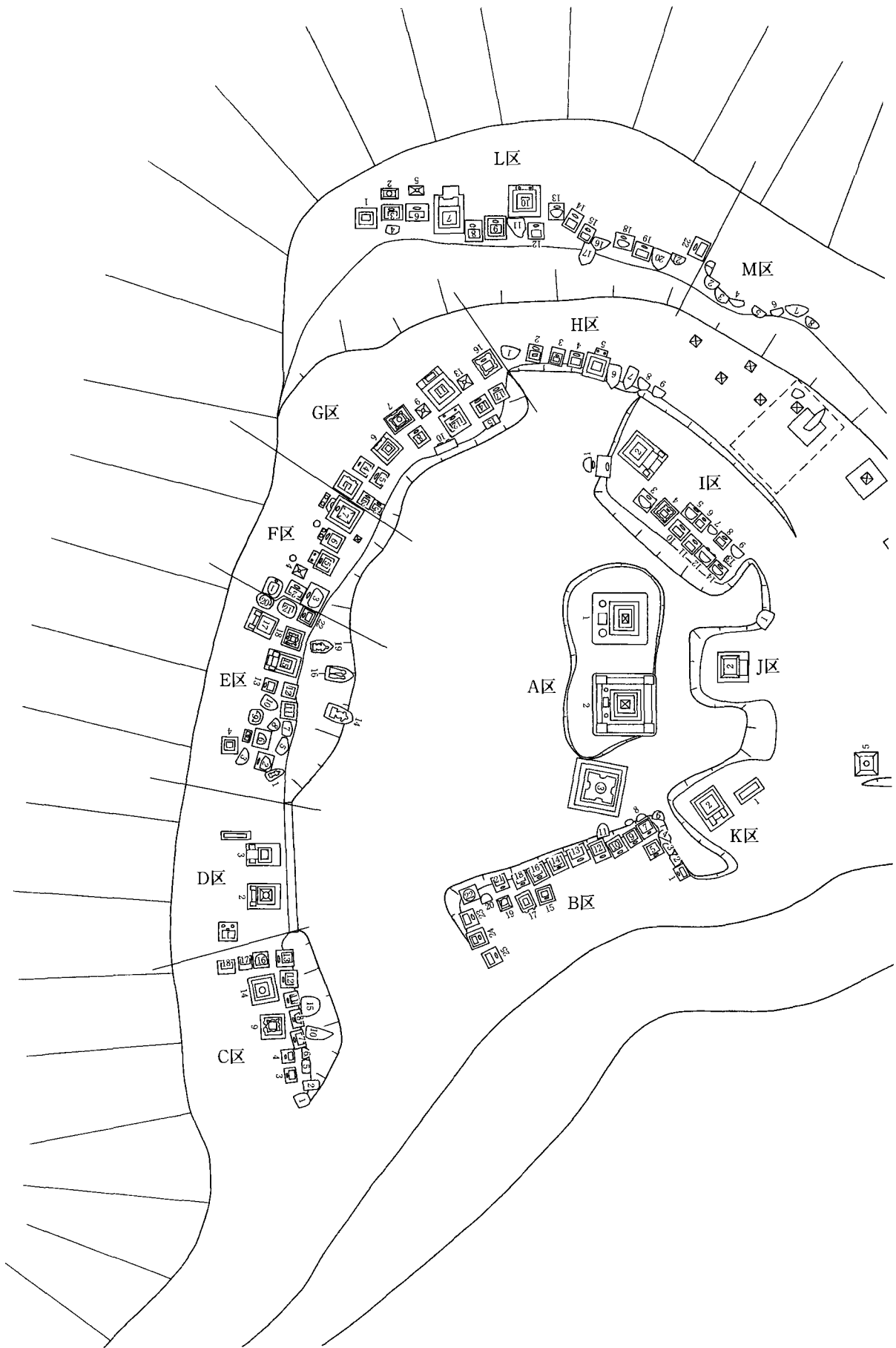

図版 47 ムシロデン墓地略測図 (1)

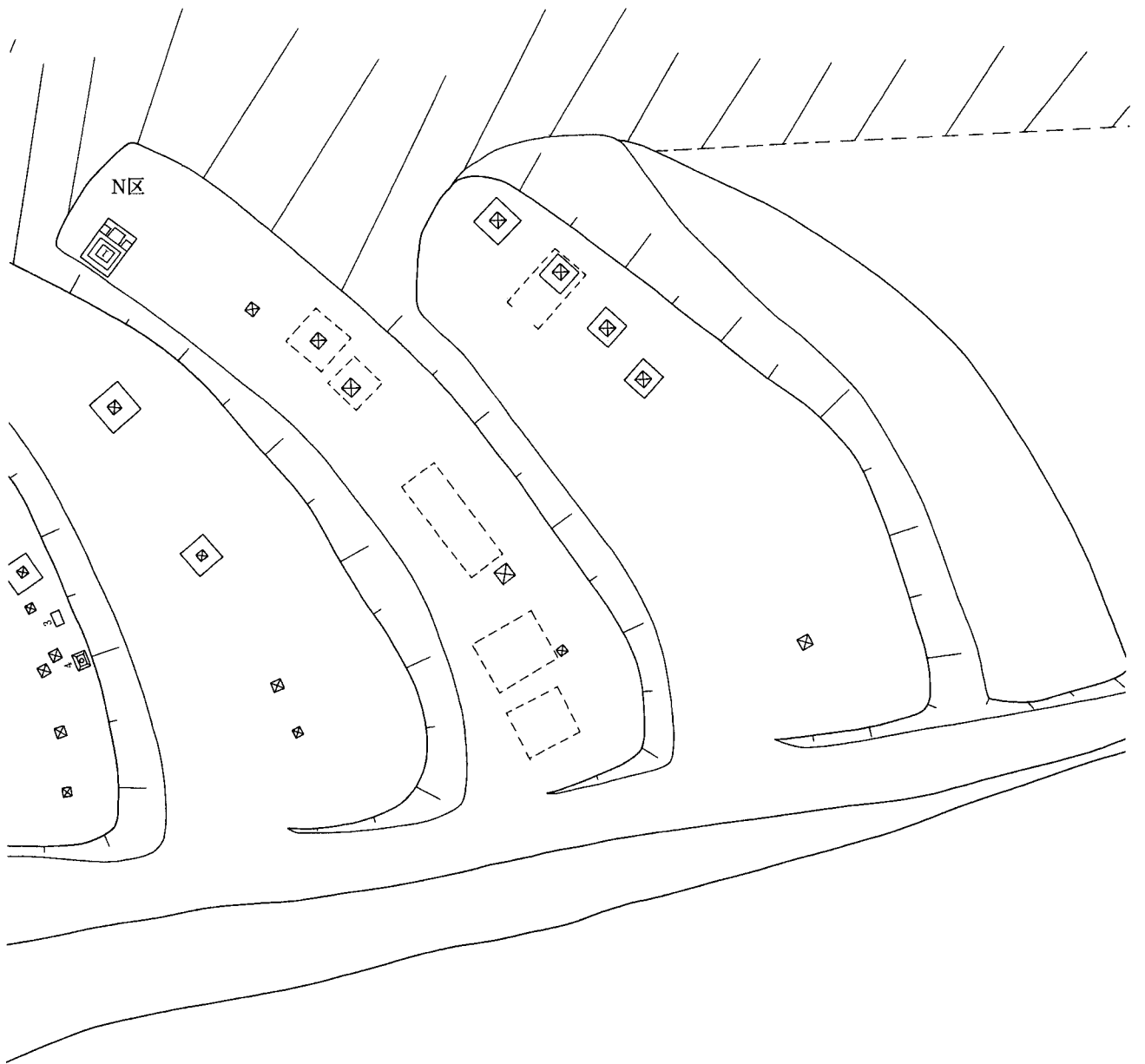

図版 48 ムシロデン墓地略測図 (2)

図版 49 平岡極楽寺墓地 地区割状況図

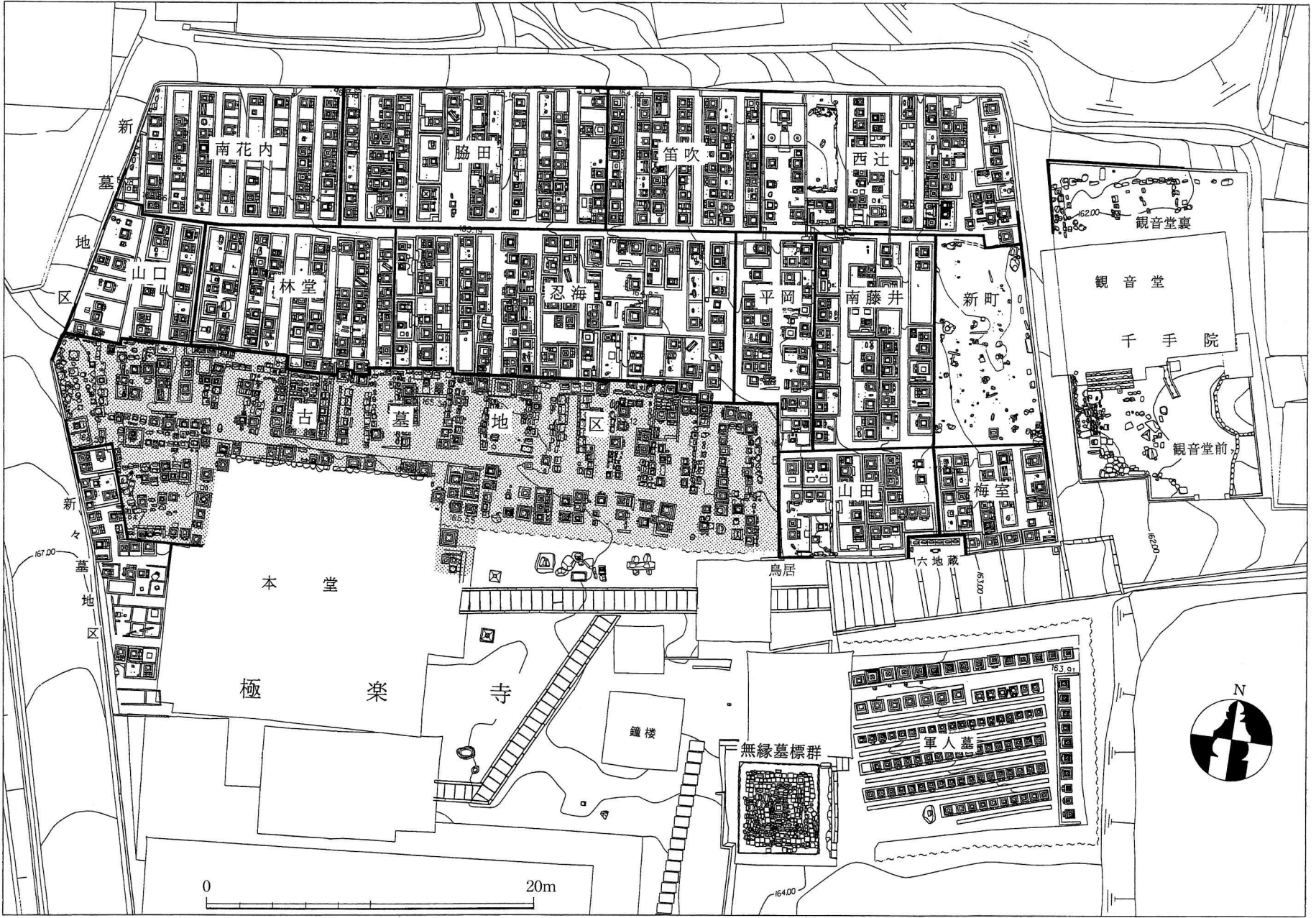

図版 50 平岡極楽寺墓地 古墓・新々墓地区 区割図

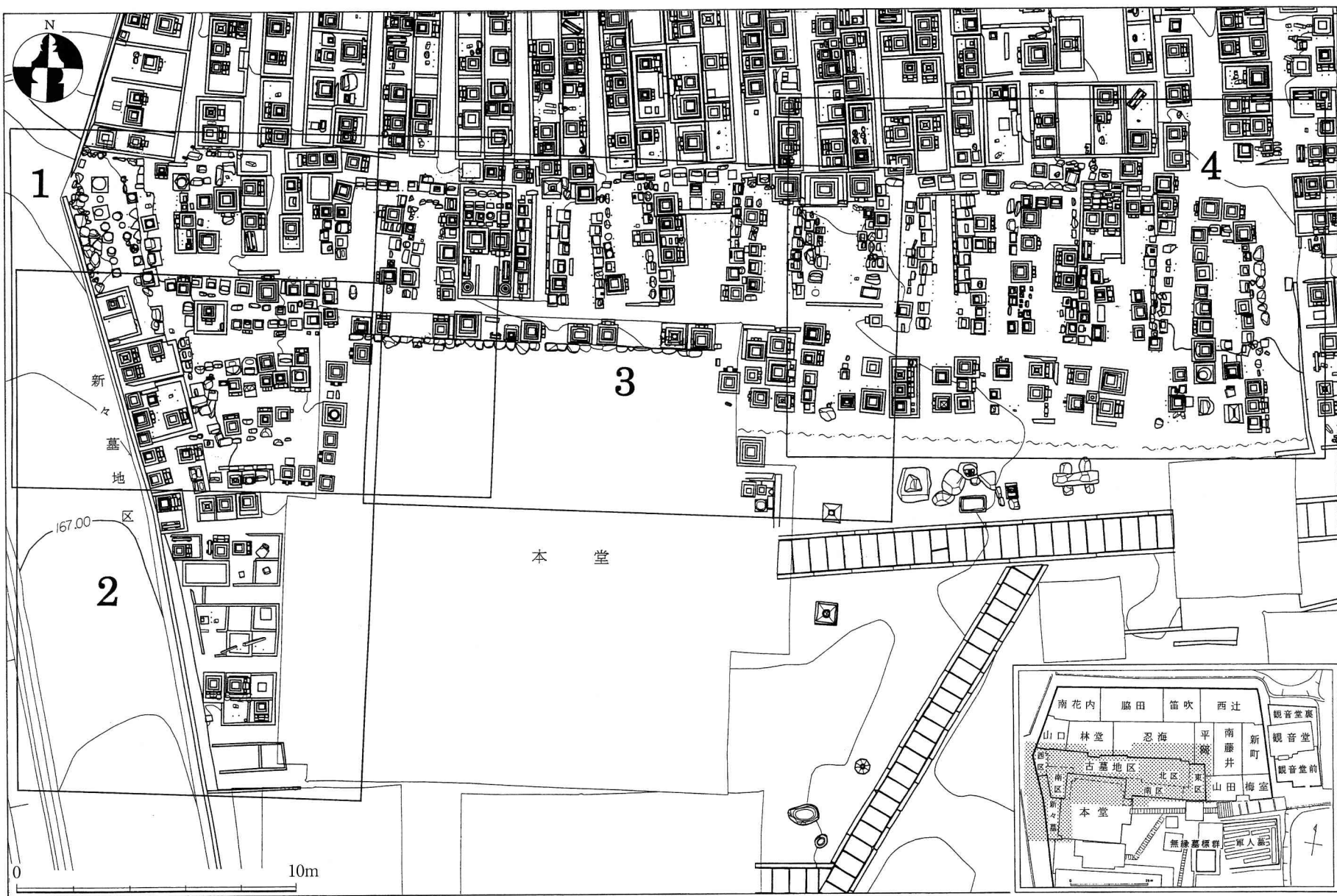



図版 51 平岡極楽寺墓地 古墳・新々墓地区 (1)

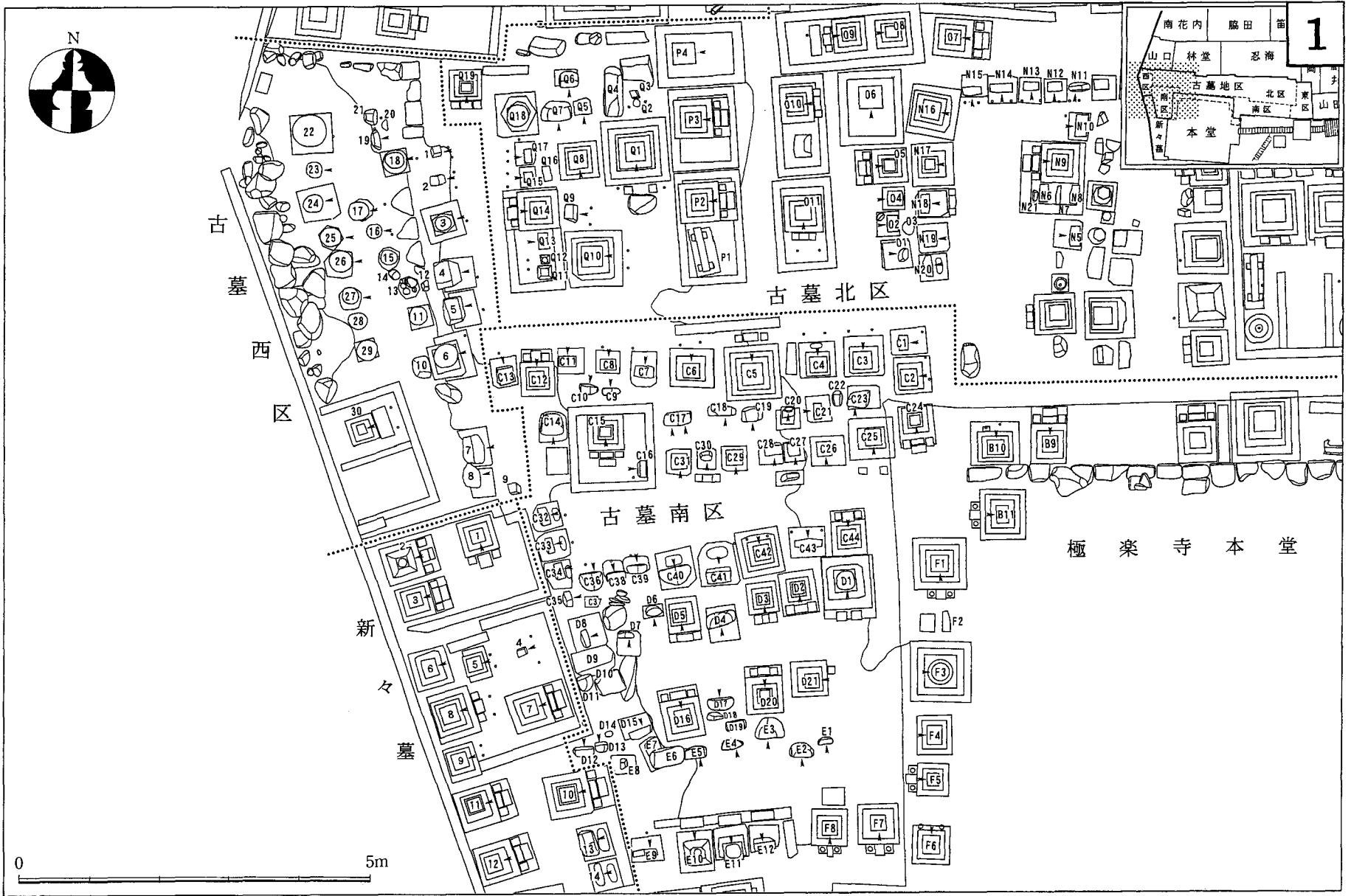

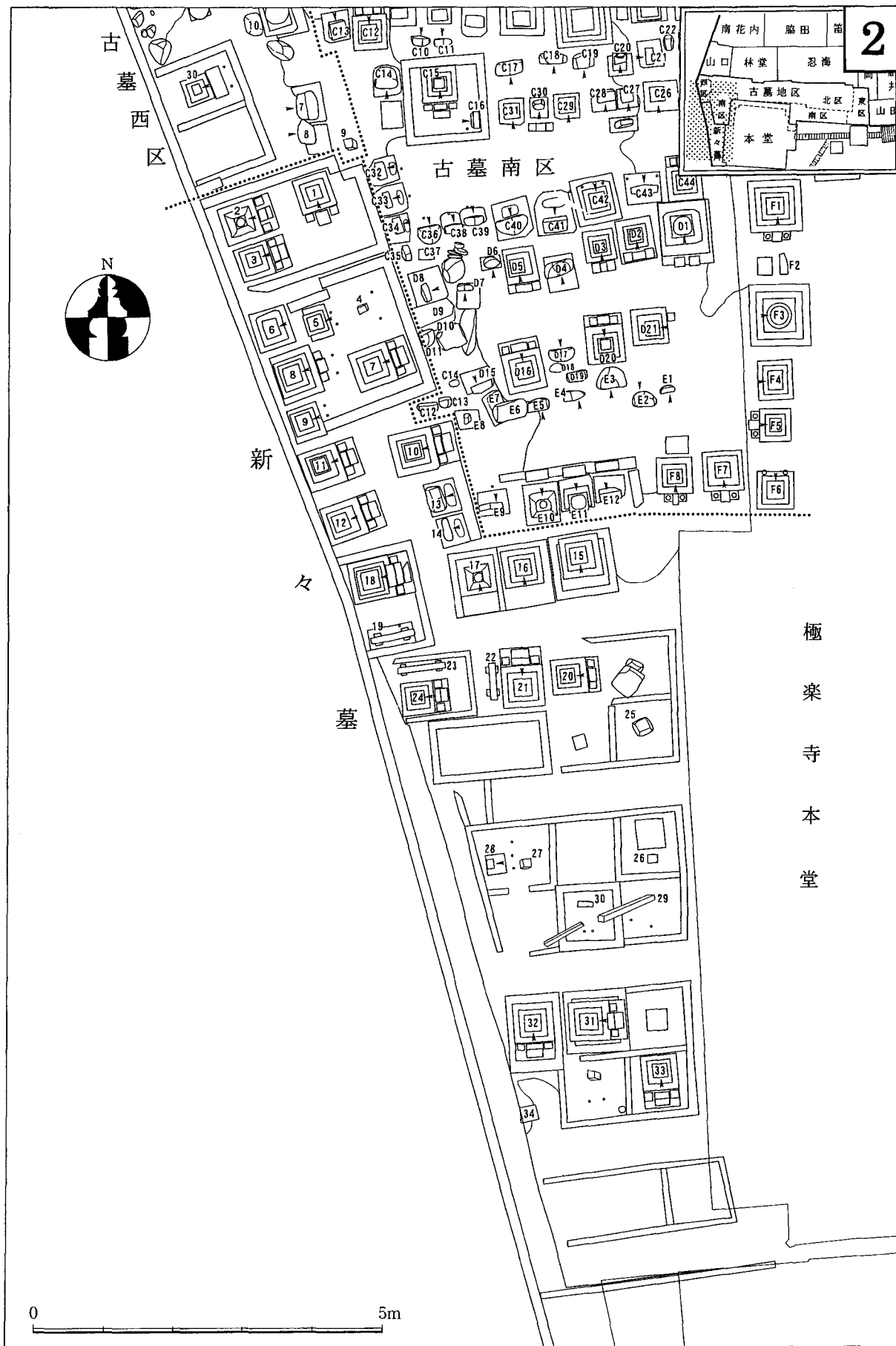

図版 52 平岡極楽寺墓地 古墓・新々墓地区 (2)

図版 53 平岡極楽寺墓地 古墳・新々墓地区 (3)

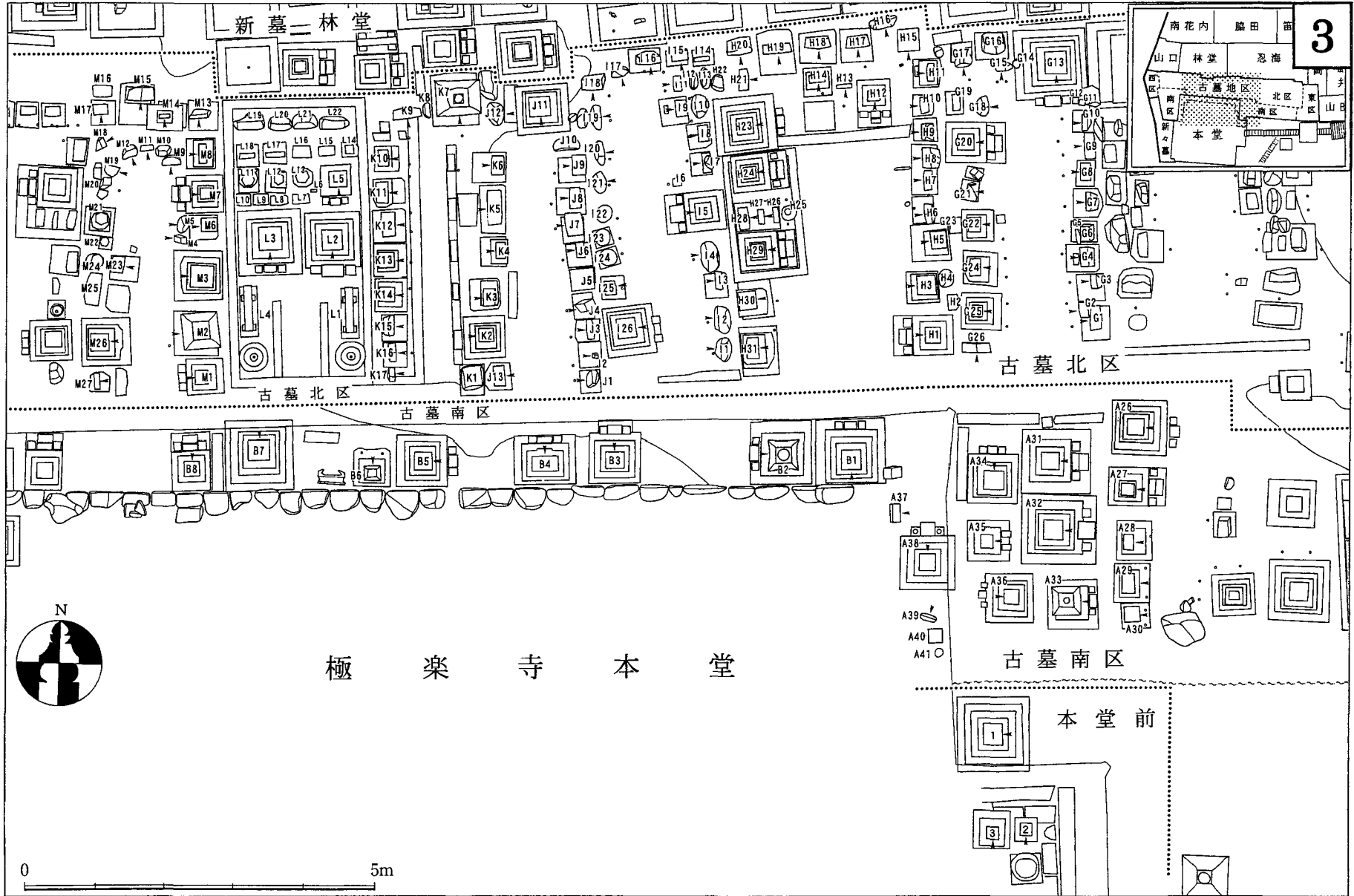

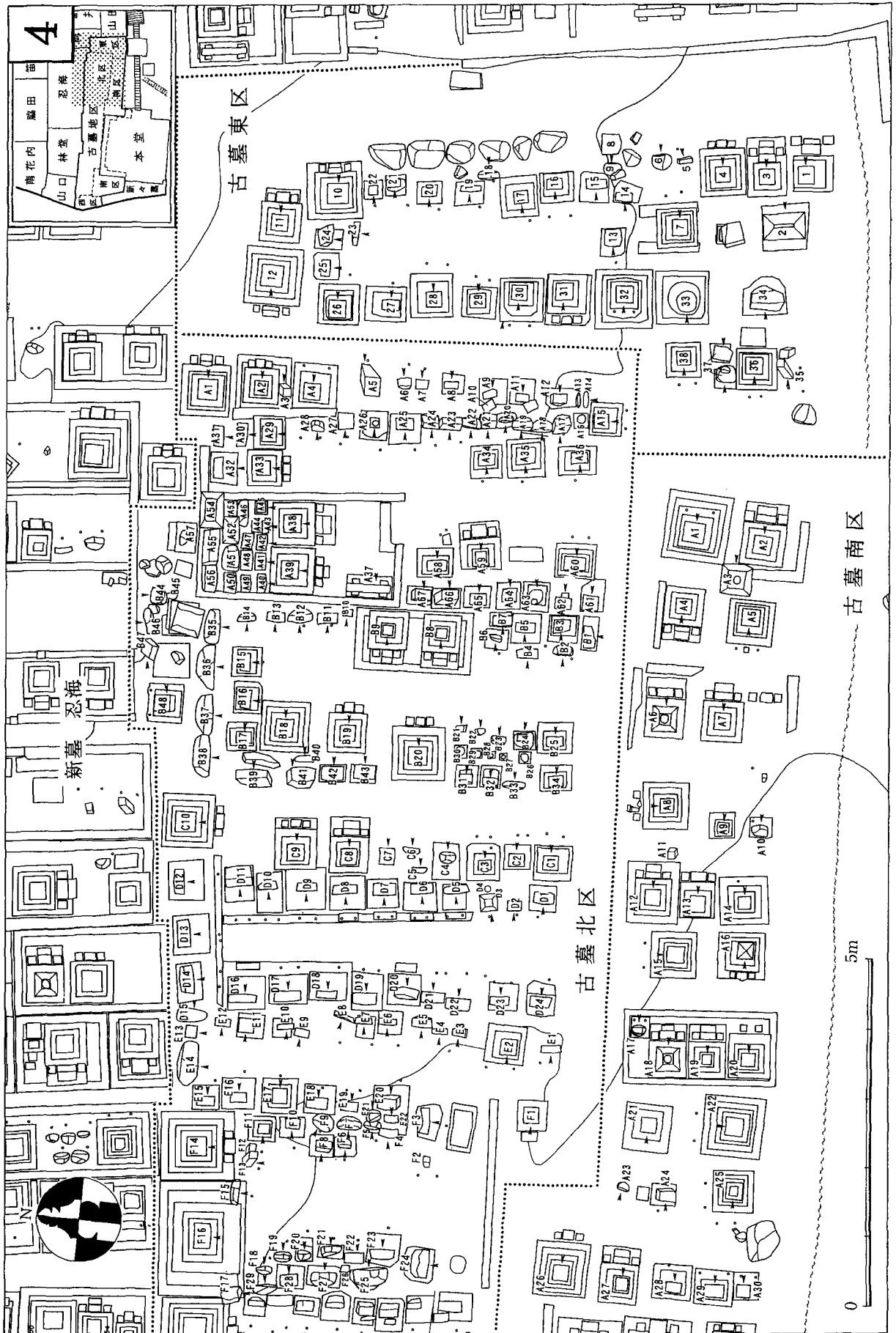

图版 54 平国福荣寺墓地 古墓·新墓地区 (4)

図版 55 平岡極楽寺墓地 新墓地区他 区割図

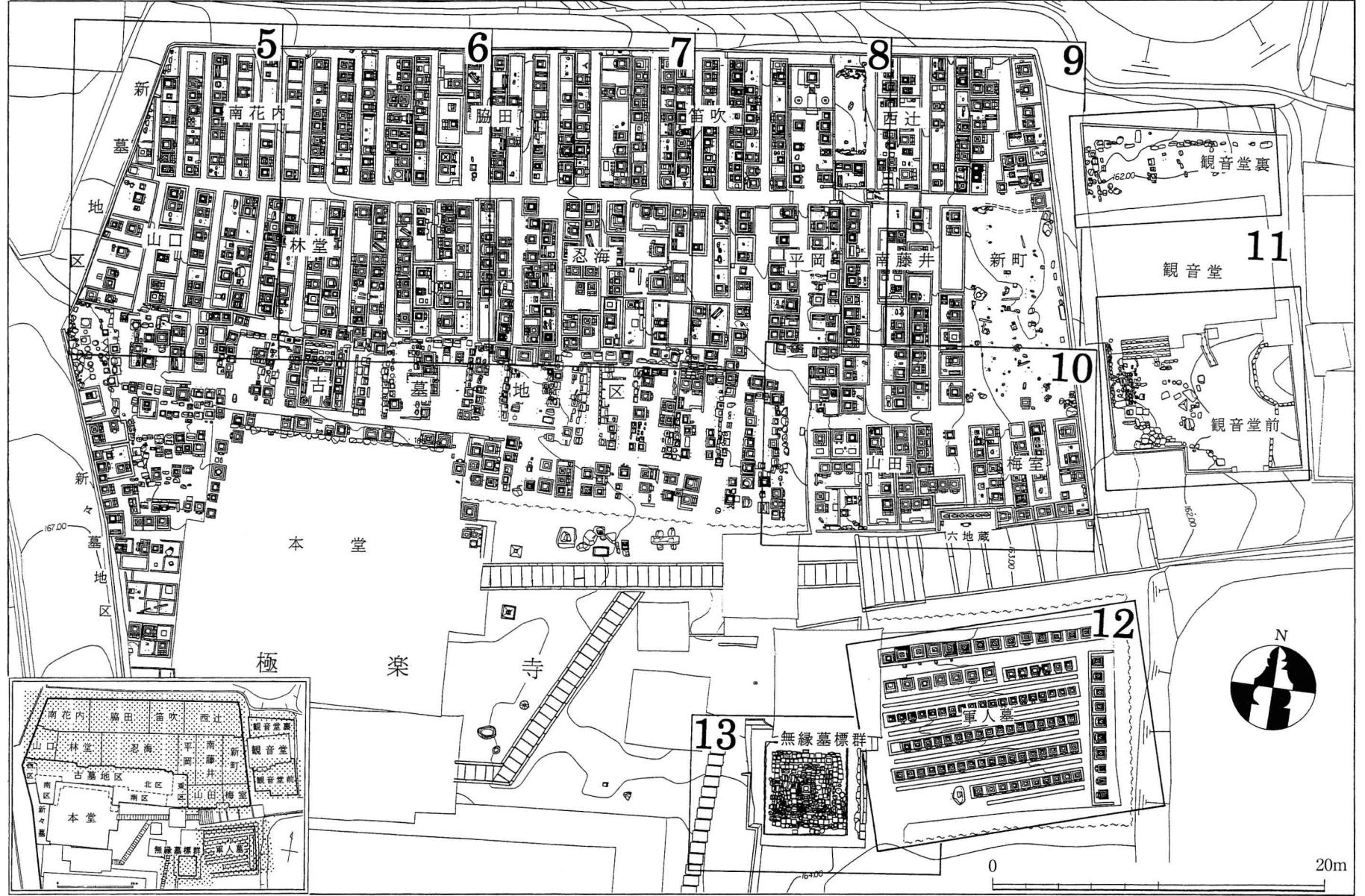



图版 56 平岡極楽寺墓地 新墓地区 (1)



图版 57 平岡極楽寺墓地 新墓地区 (2)

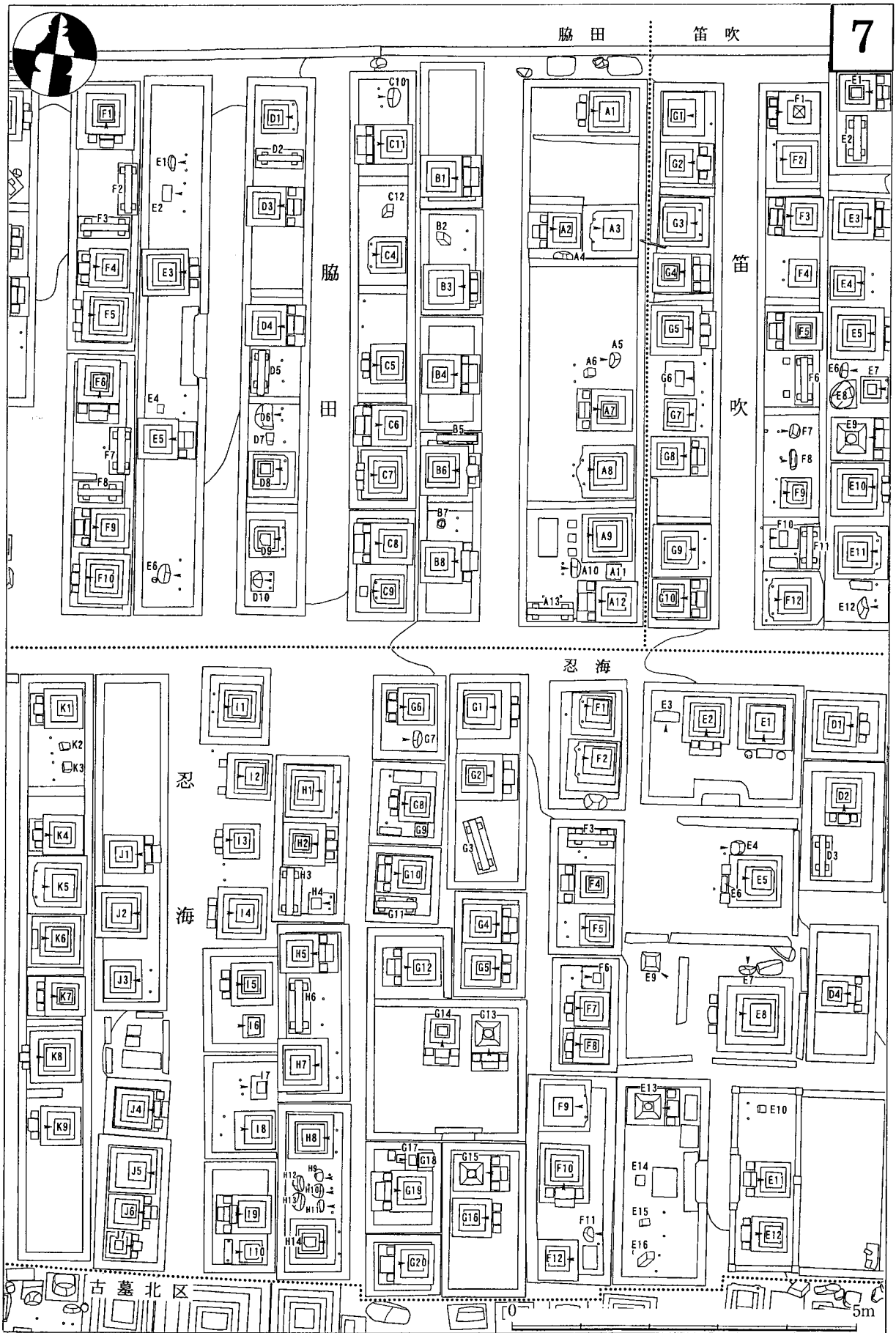

図版 58 平岡極楽寺墓地 新墓地区 (3)

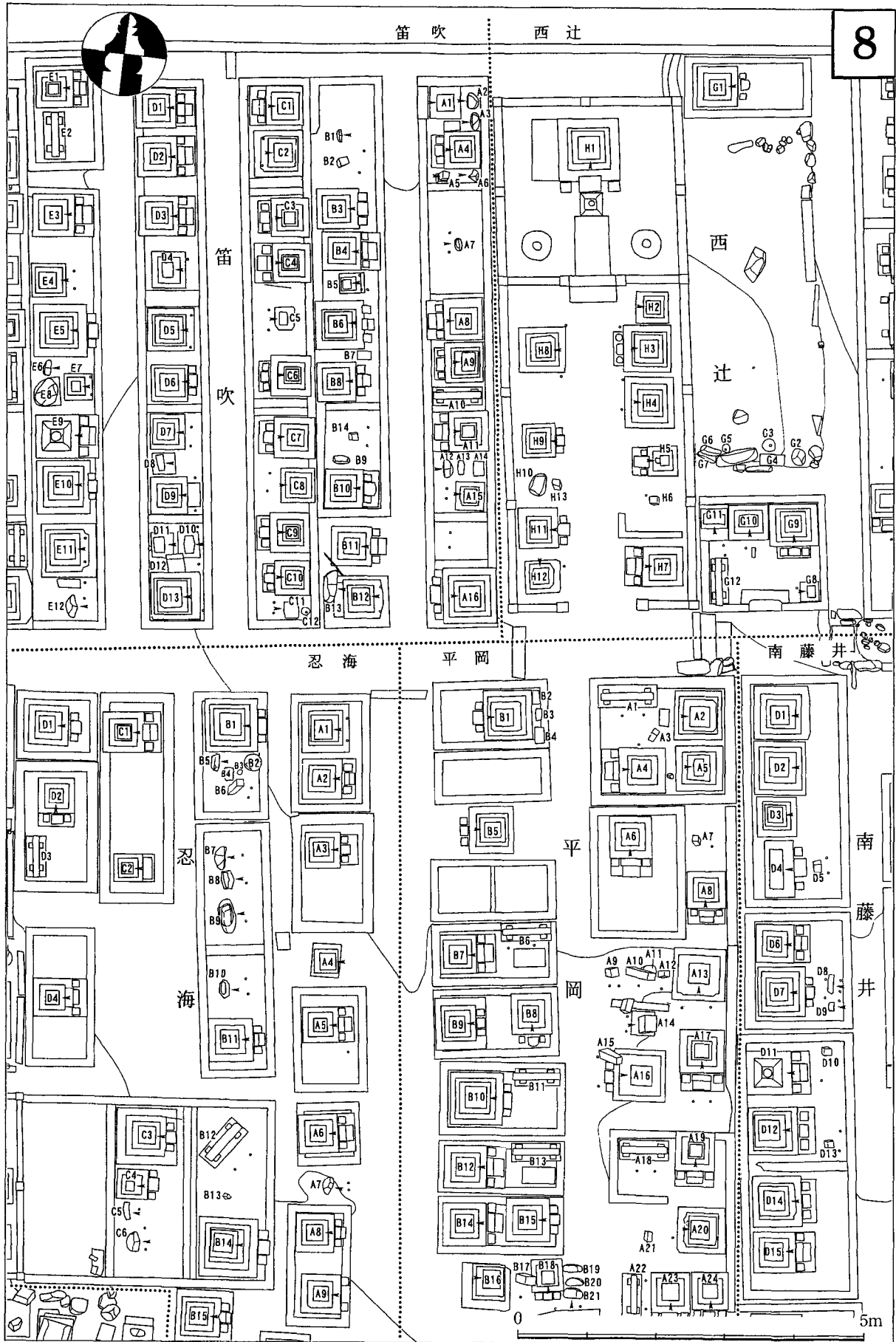

図版 59 平岡極楽寺墓地 新墓地区 (4)



图版 60 平岡極楽寺墓地 新墓地区 (5)

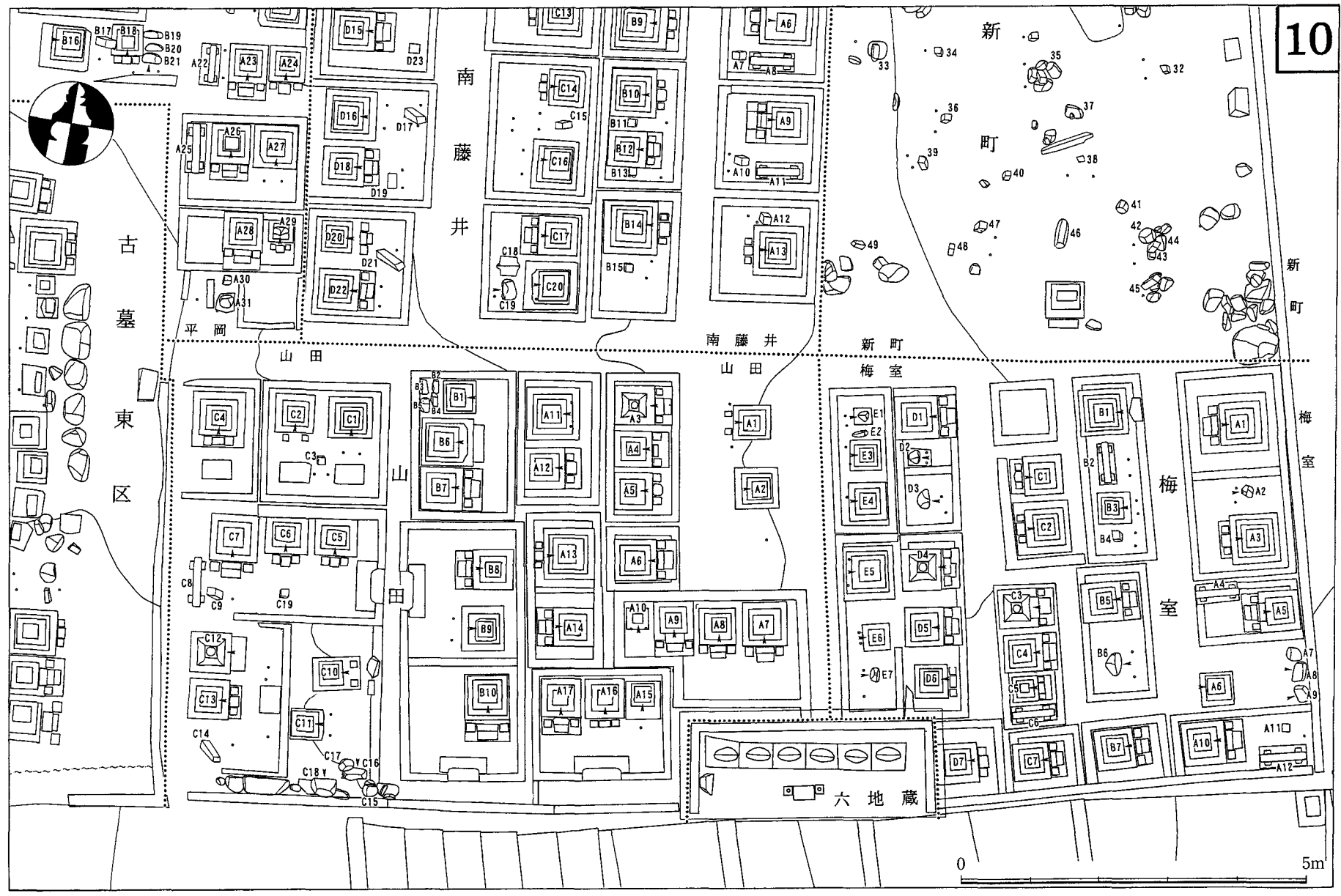

図版 61 平岡極楽寺墓地 新墓地区 (9)

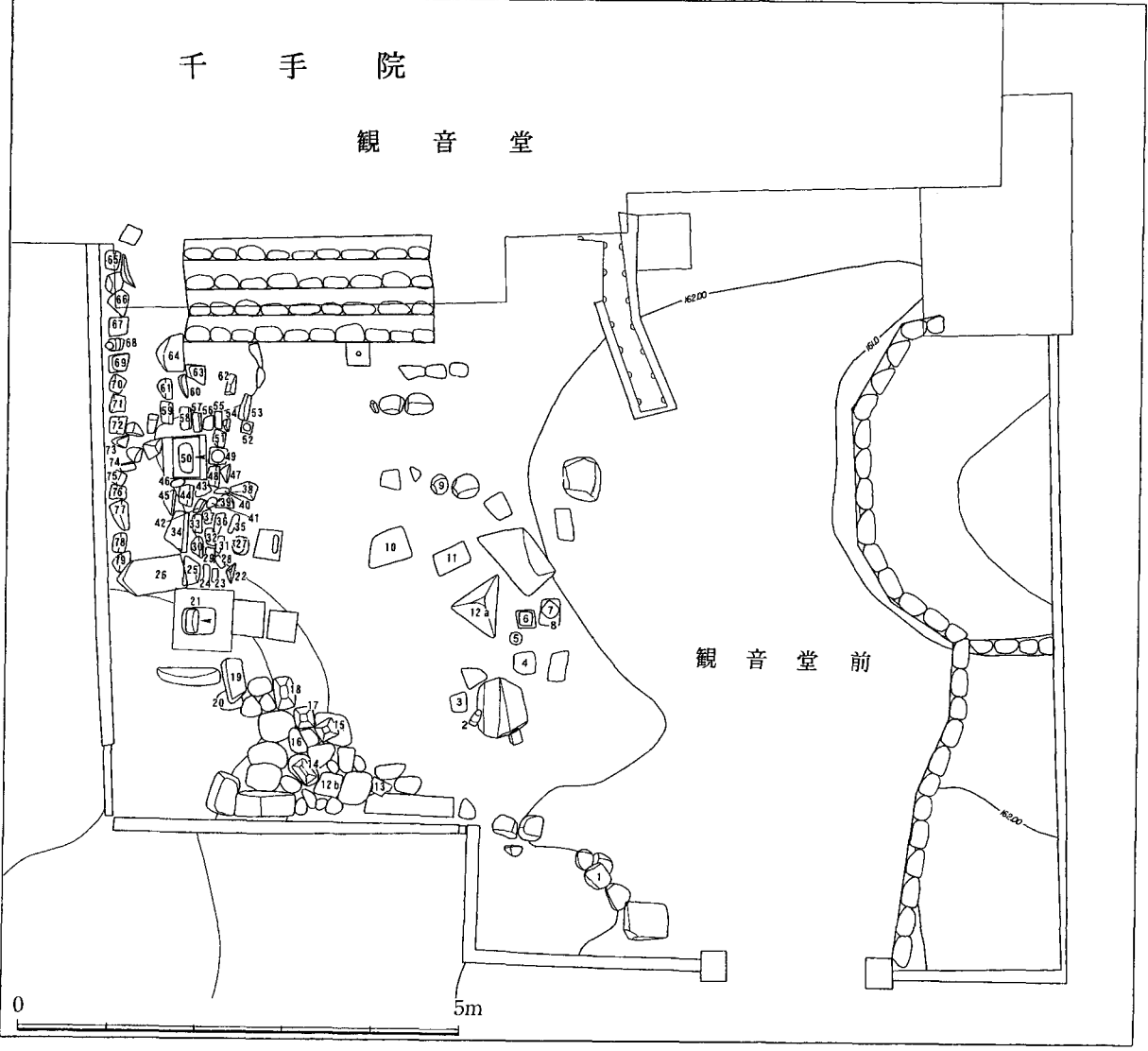
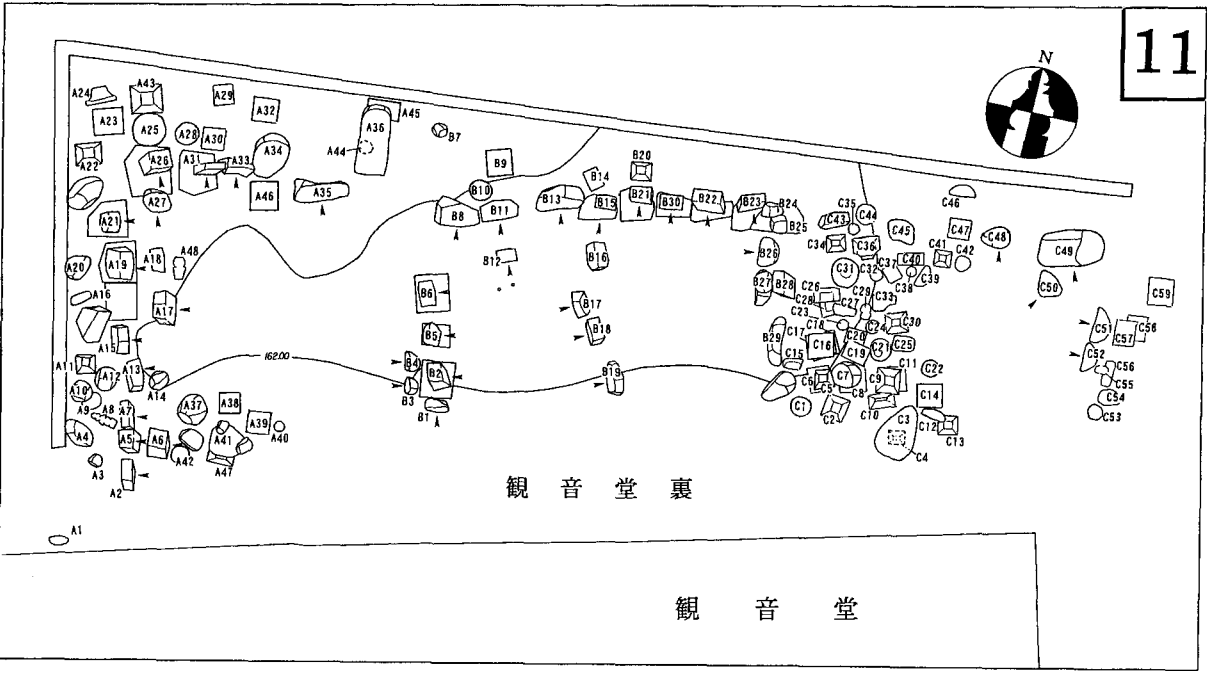

図版 62 平岡極楽寺墓地 観音堂裏・前地区

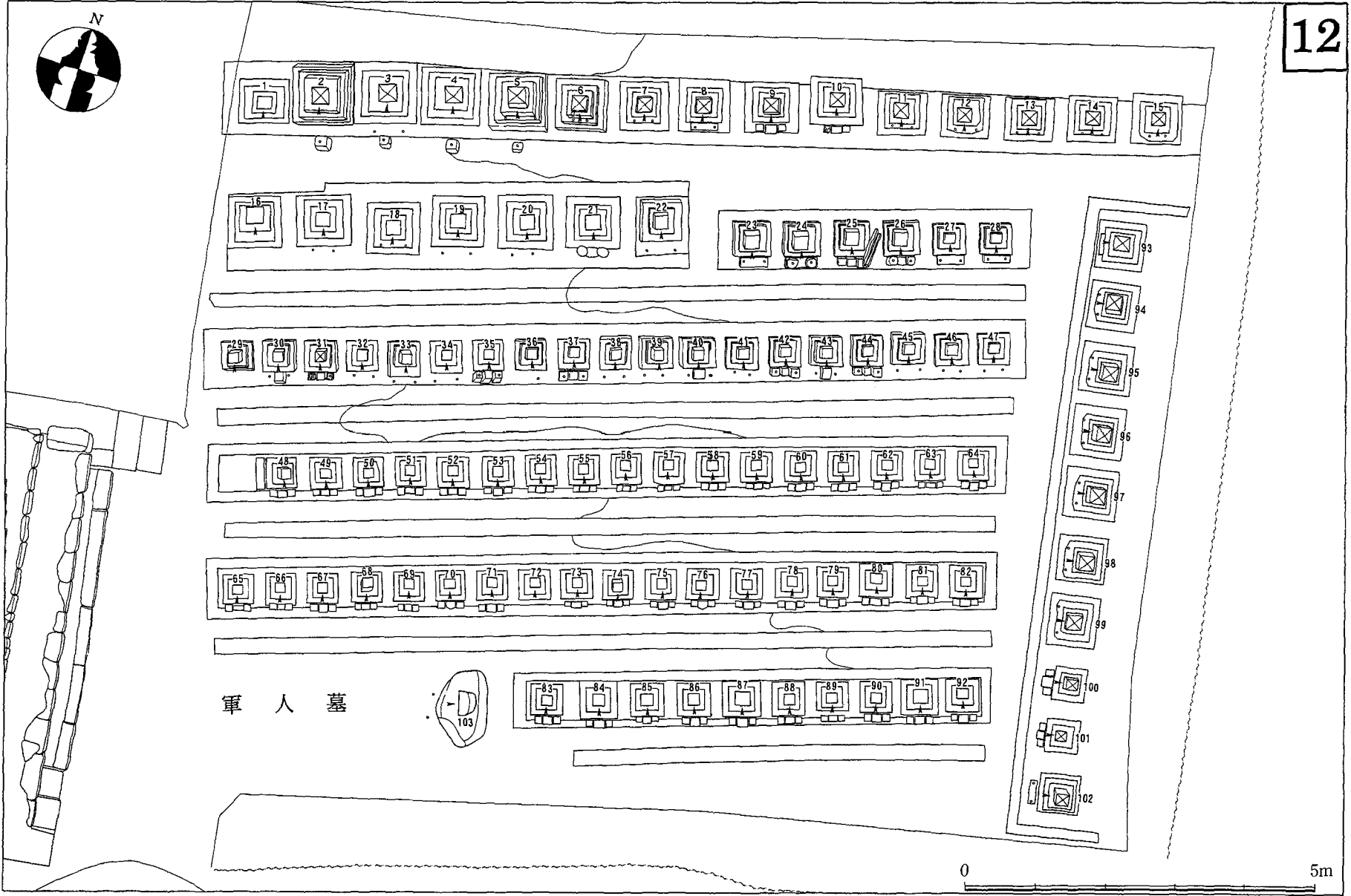

図版 63 平岡極楽寺墓地 軍人墓

納骨堂

軍人墓

無縁墓標群

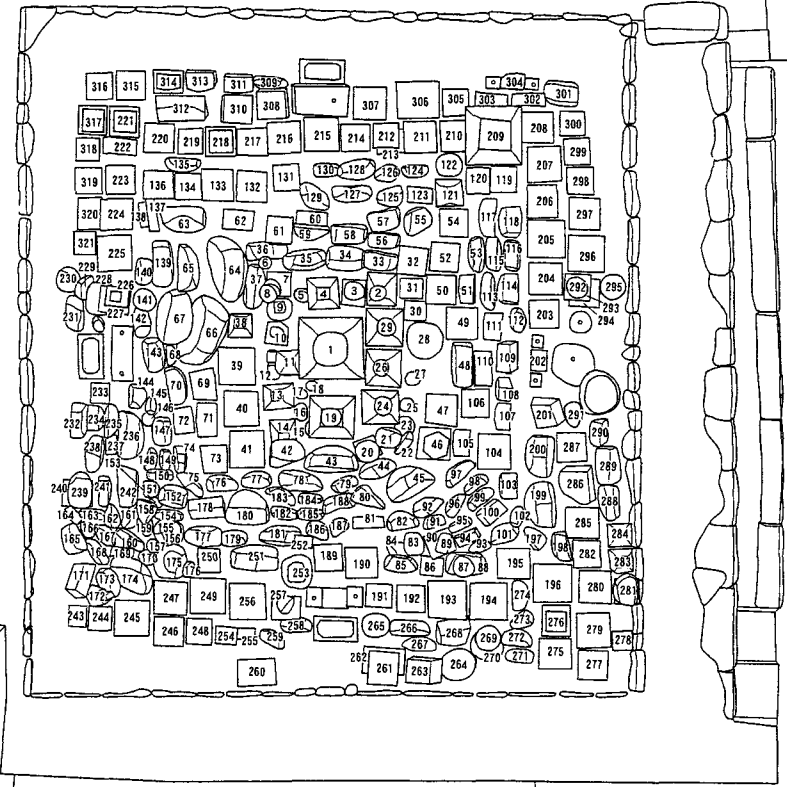

図版 64 平岡極楽寺墓地 無縁墓標群

庫裏

境

内

外

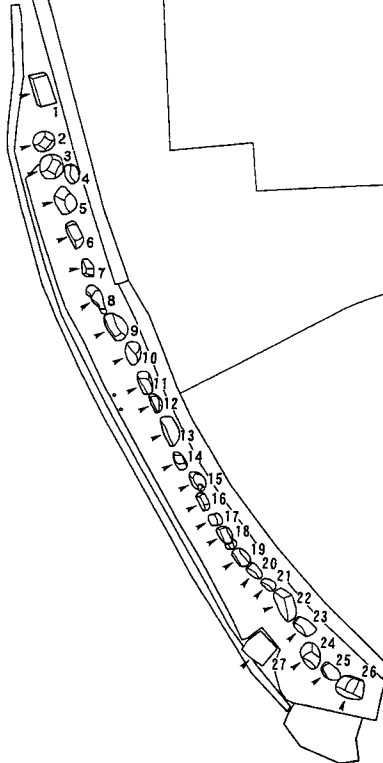

図版 65 平岡極楽寺墓地 境内外

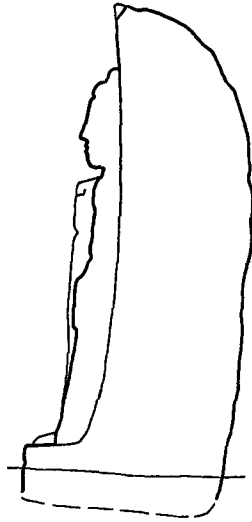

1

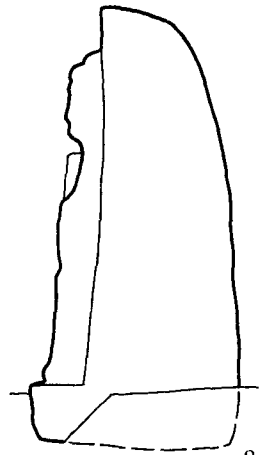

2

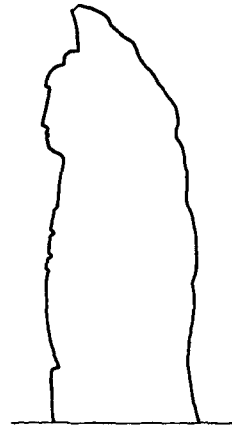

3



寬保元酉年
紅山海智
十月十九日

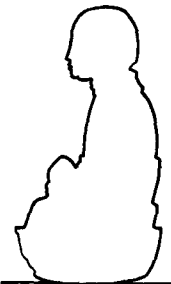

寬保元酉年

4

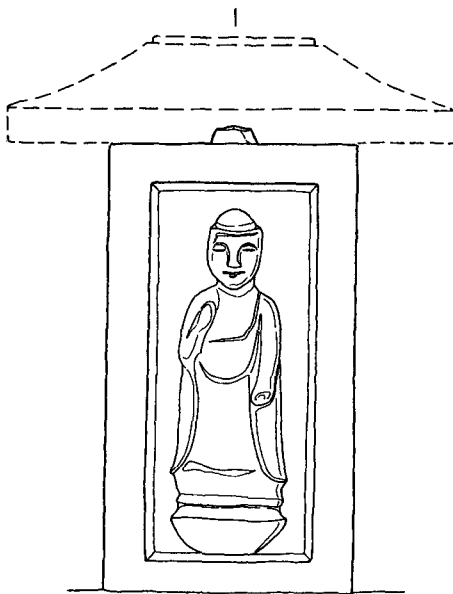

5



5

- 1 有像舟形 (古北I-10, 大永七年: 1527)
- 2 有像舟形 (古北N-1, 大永七年: 1527)
- 3 有像舟形 (古北I-17, 永祿十一年: 1568)
- 4 丸彫形 (古北G-17, 寬保元年: 1741)
- 5 箱仏 (境内外1)

0 1/10 50cm

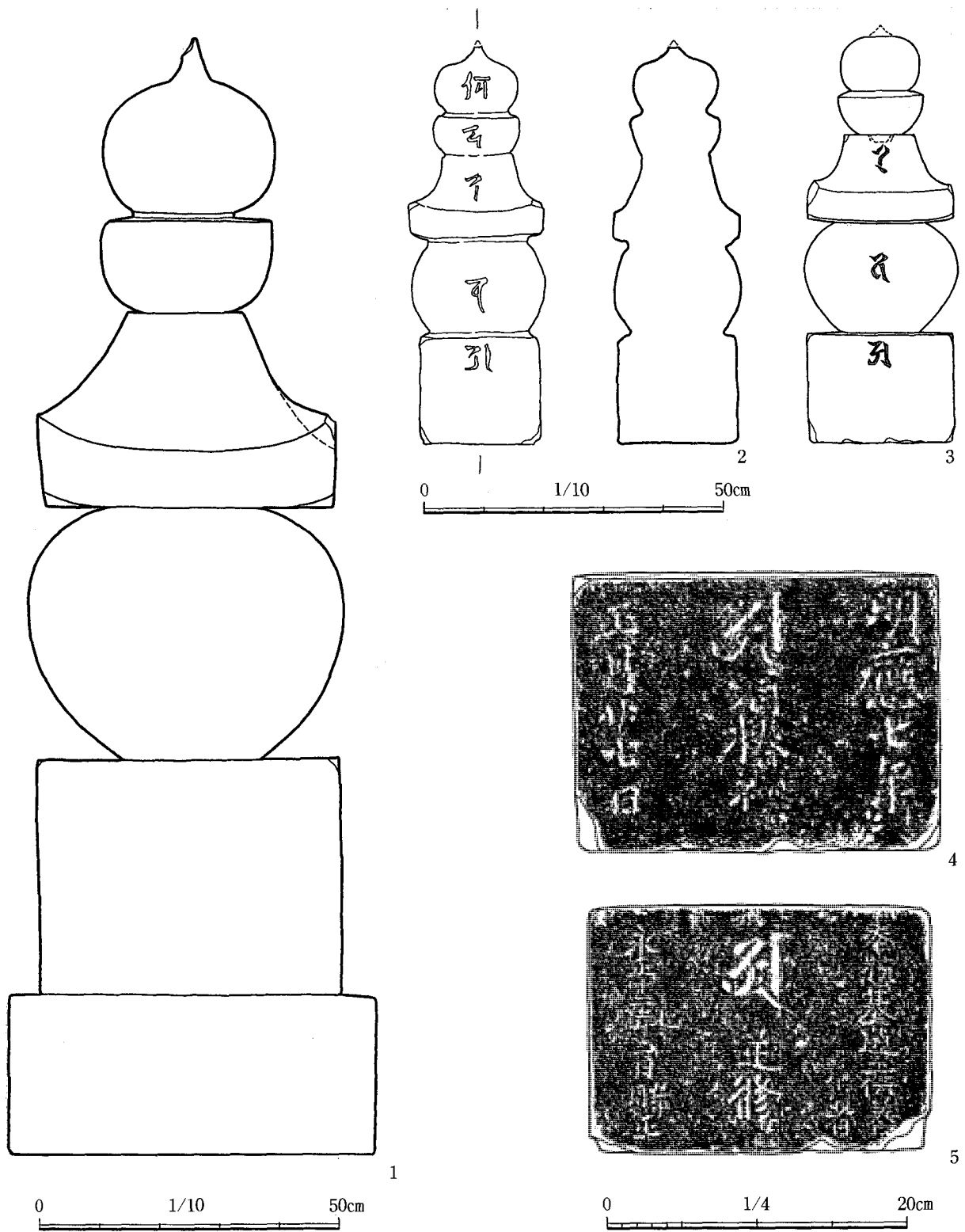

- 1 別石五輪塔（無縁墓標群 1）
- 2 一石五輪塔（古北B-30）
- 3 別石五輪塔（法城寺山門前，明応七年：1498）
- 4 3の地輪の拡大
- 5 別石五輪塔地輪（無縁墓標群 293，永正十二年：1515）

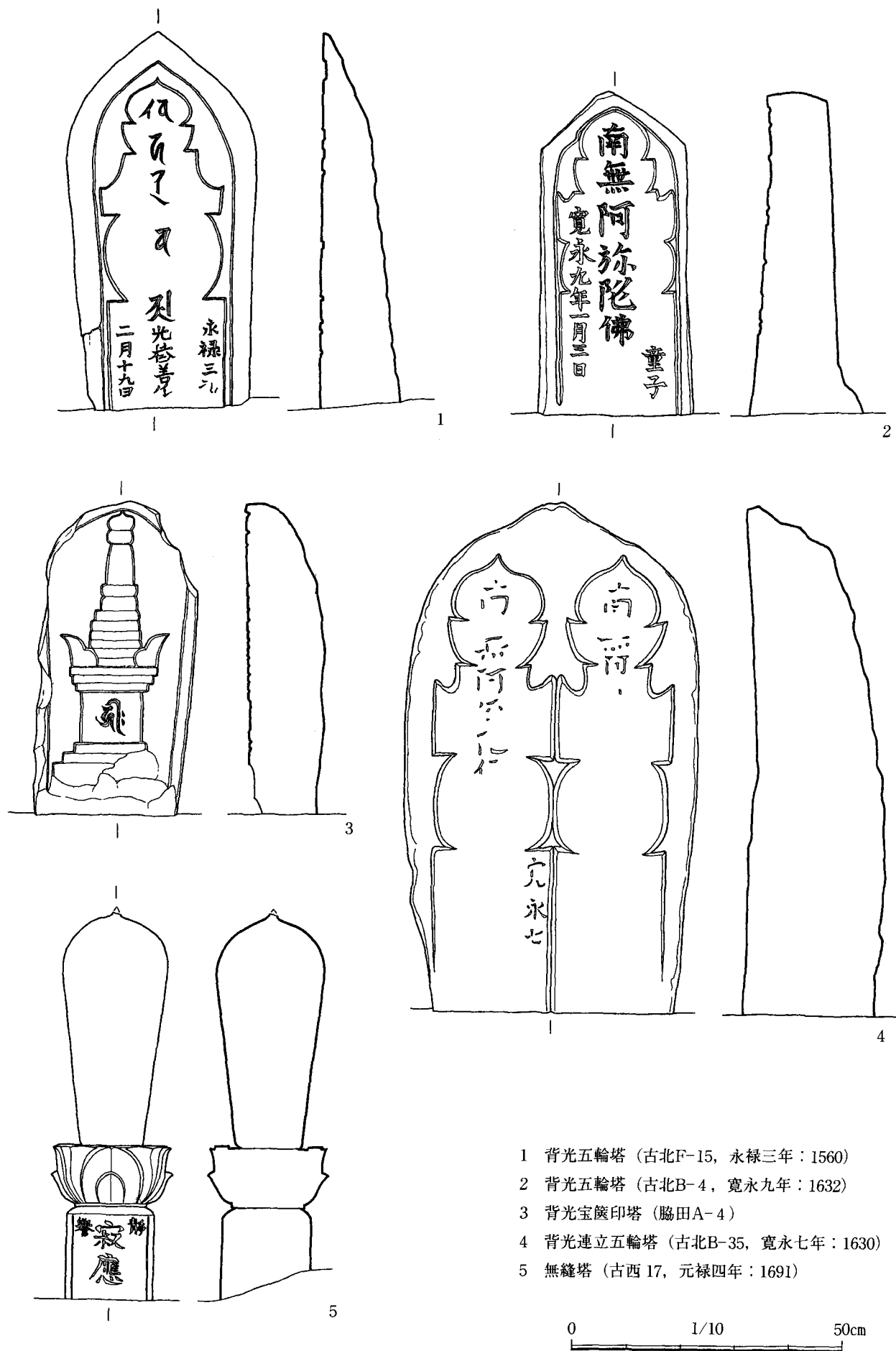

- 1 背光五輪塔 (古北F-15, 永祿三年: 1560)
- 2 背光五輪塔 (古北B-4, 寛永九年: 1632)
- 3 背光宝篋印塔 (脇田A-4)
- 4 背光連立五輪塔 (古北B-35, 寛永七年: 1630)
- 5 無縫塔 (古西 17, 元祿四年: 1691)

0 1/10 50cm

図版 68 平岡極楽寺墓地 石塔 (3)

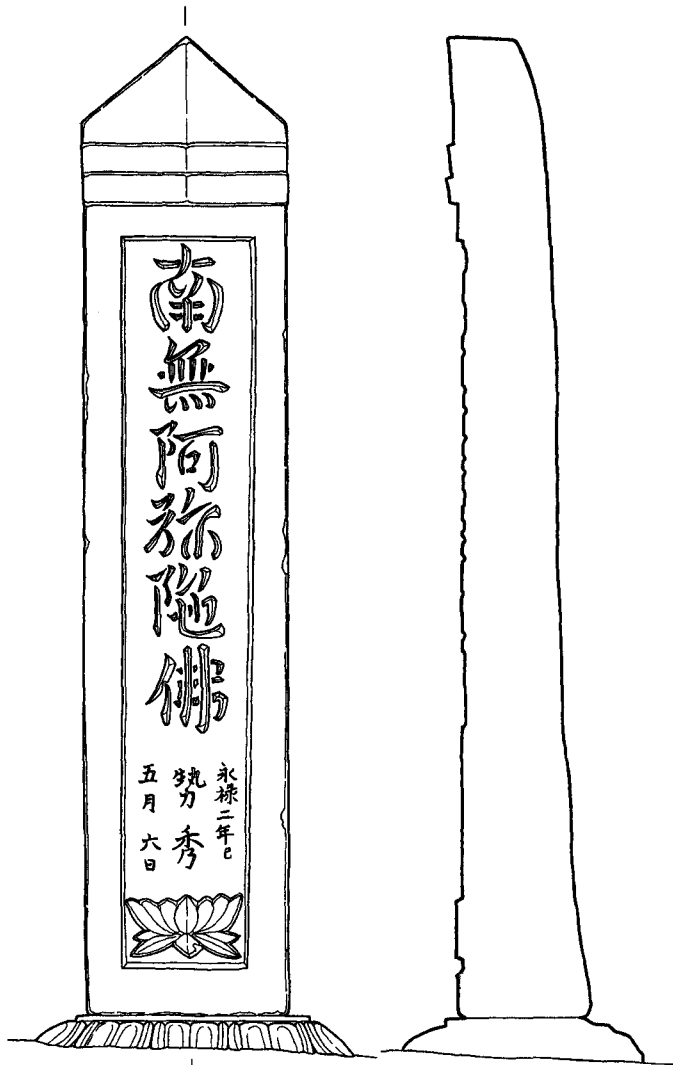

1 板碑形 (古北F-24, 永祿二年: 1559)

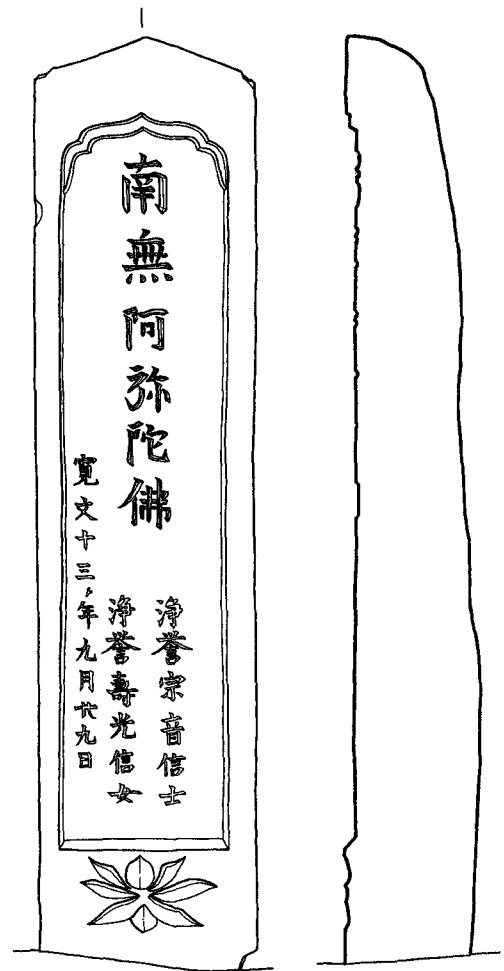

2 駒形 (古北K-9, 寛文十三年: 1673)

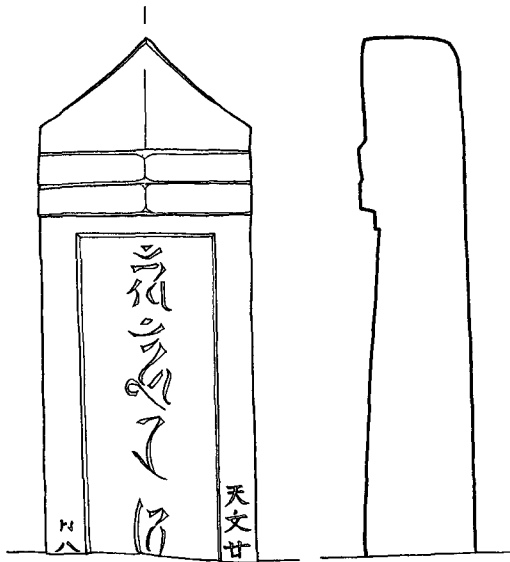

3 板碑形 (古北G-26, 天文二十年: 1551)

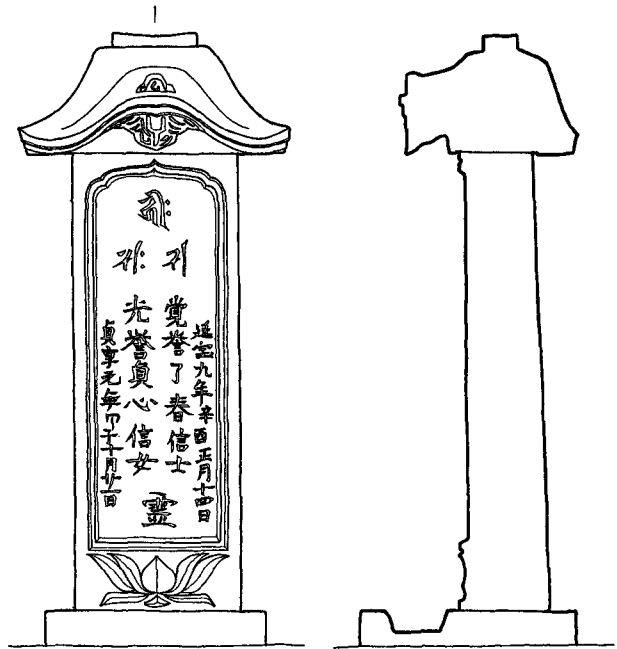

4 笠塔婆 (古北M-14, 貞享元年: 1684)

0 1/15 1m

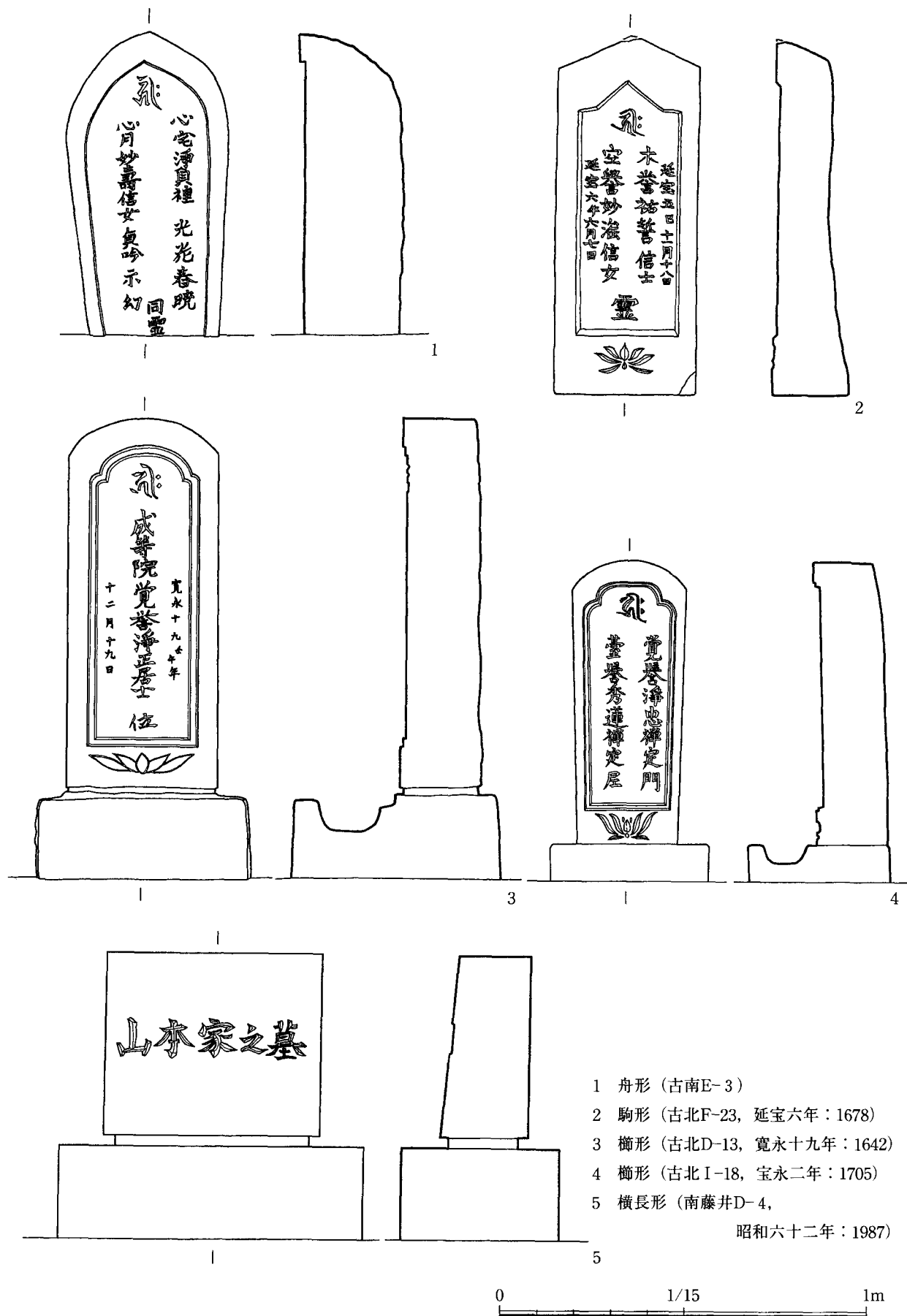

- 1 舟形 (古南E-3)
- 2 駒形 (古北F-23, 延宝六年: 1678)
- 3 櫛形 (古北D-13, 寛永十九年: 1642)
- 4 櫛形 (古北I-18, 宝永二年: 1705)
- 5 横長形 (南藤井D-4, 昭和六十二年: 1987)

図版 70 平岡極楽寺墓地 石塔 (5)

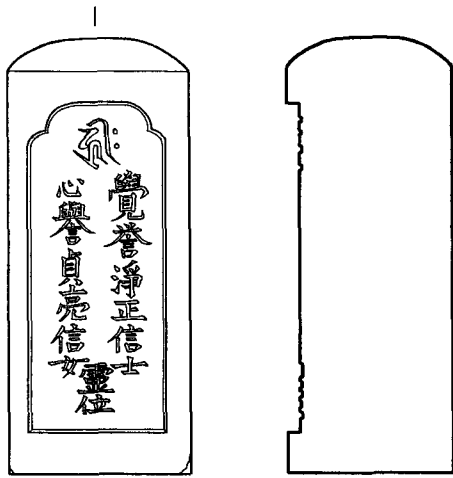
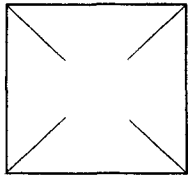

1 丘状頭角柱 (古北A-64, 明和二年: 1765)

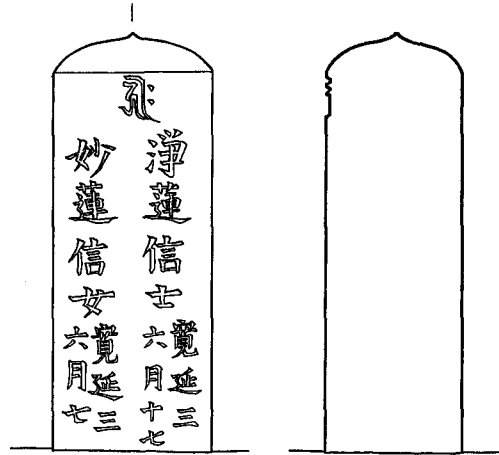
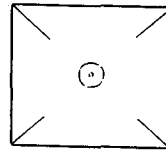

2 丘状頭角柱 (有突起) (古北C-7, 寛延三年: 1750)

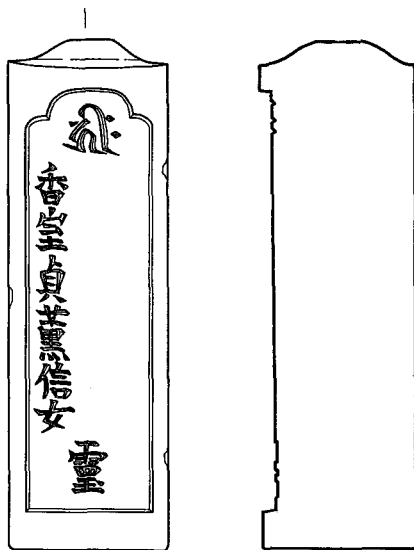
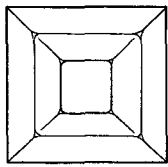

3 角台頭角柱 (観音堂裏A-6, 寛政四年: 1752)

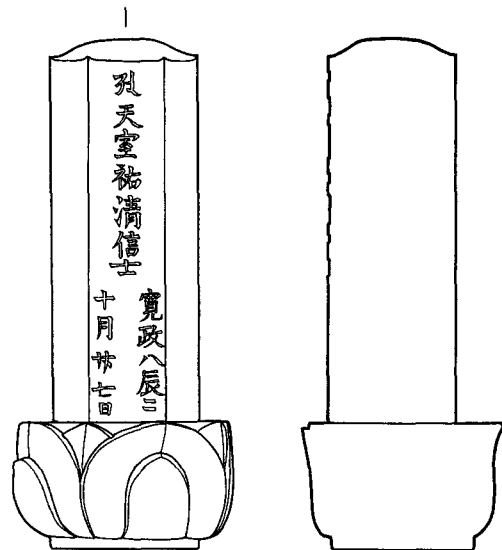
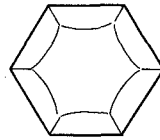

4 六角無縫塔 (古北L-11, 文政年間: 1818~30)

0 1/10 50cm

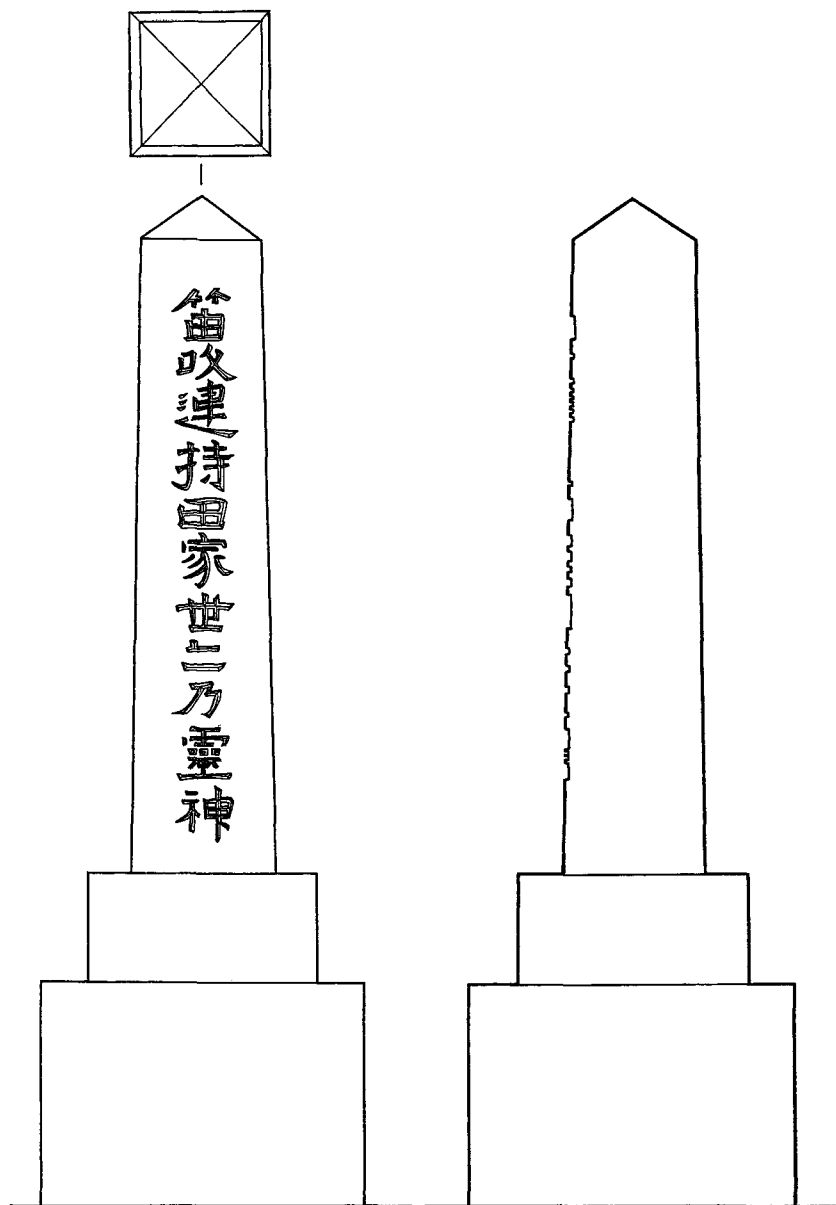

1 尖頭角柱 (笛吹F-2, 明治三十九年:1906)

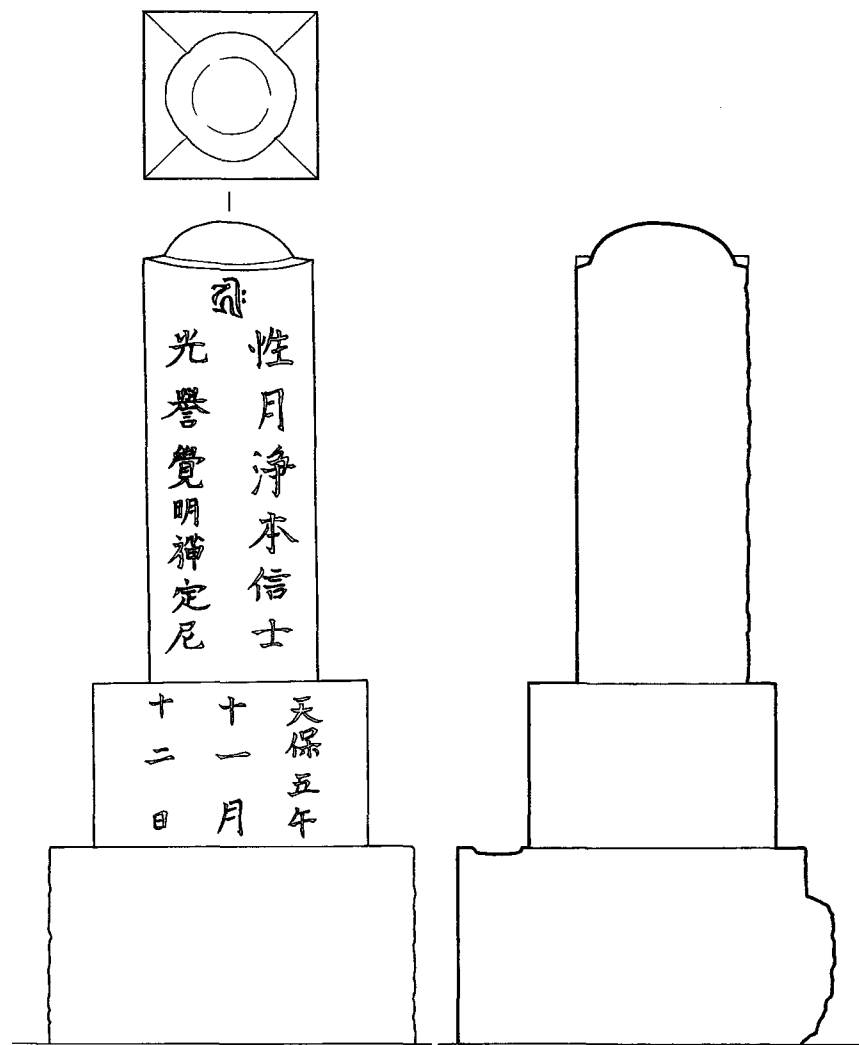

2 丸台頭角柱 (古南D-1, 天保五年:1834)

0 1/15 1m

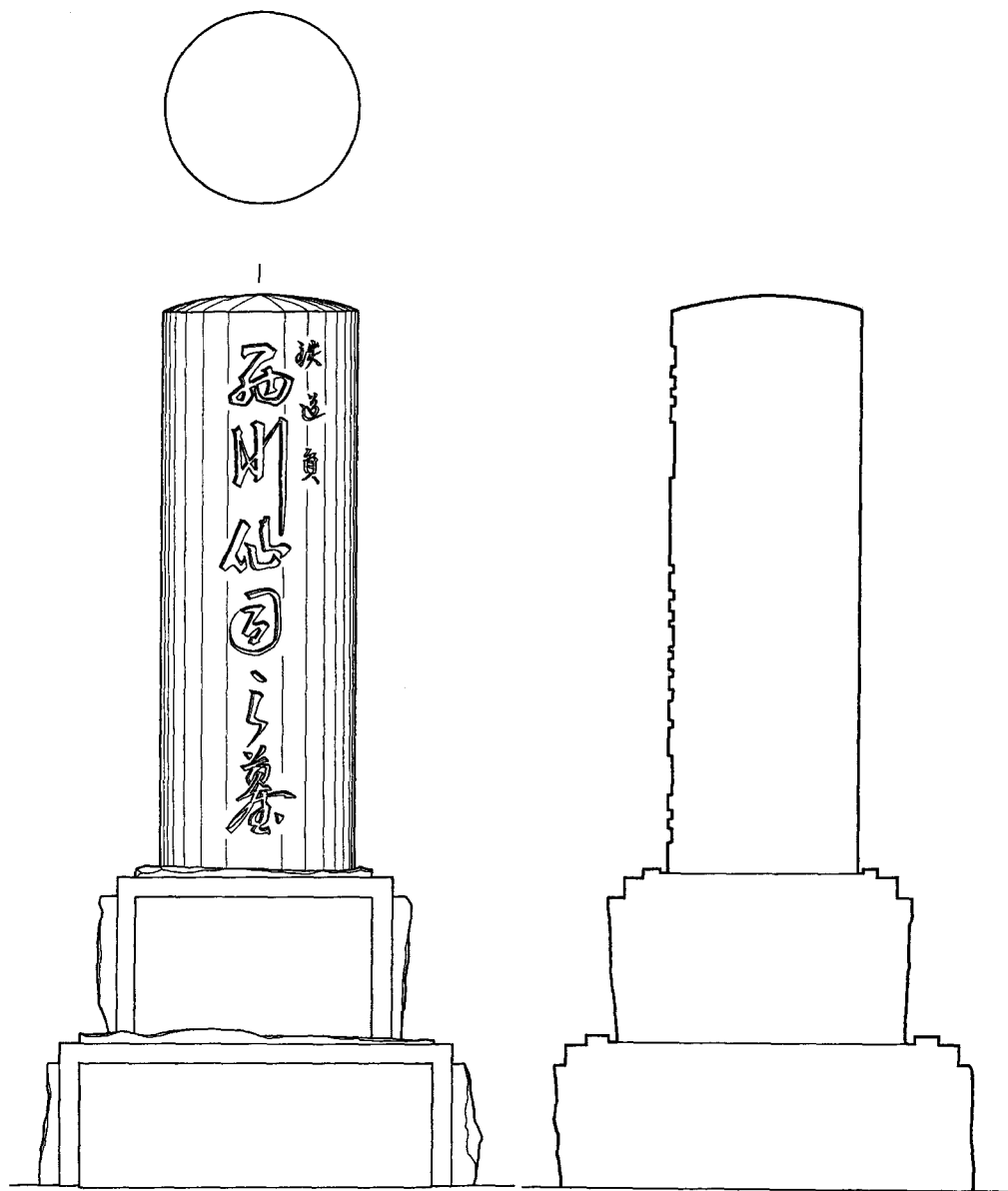

1 円柱 (脇田 J-17, 明治四十二年: 1909)

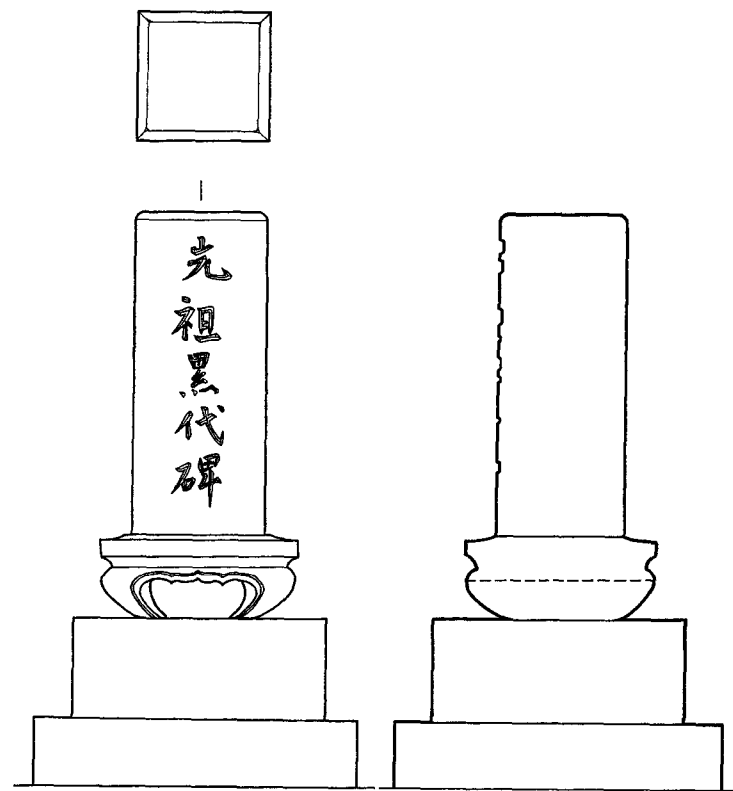

2 平頭角柱 (古南 A-5, 明治十五年: 1882)

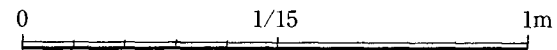

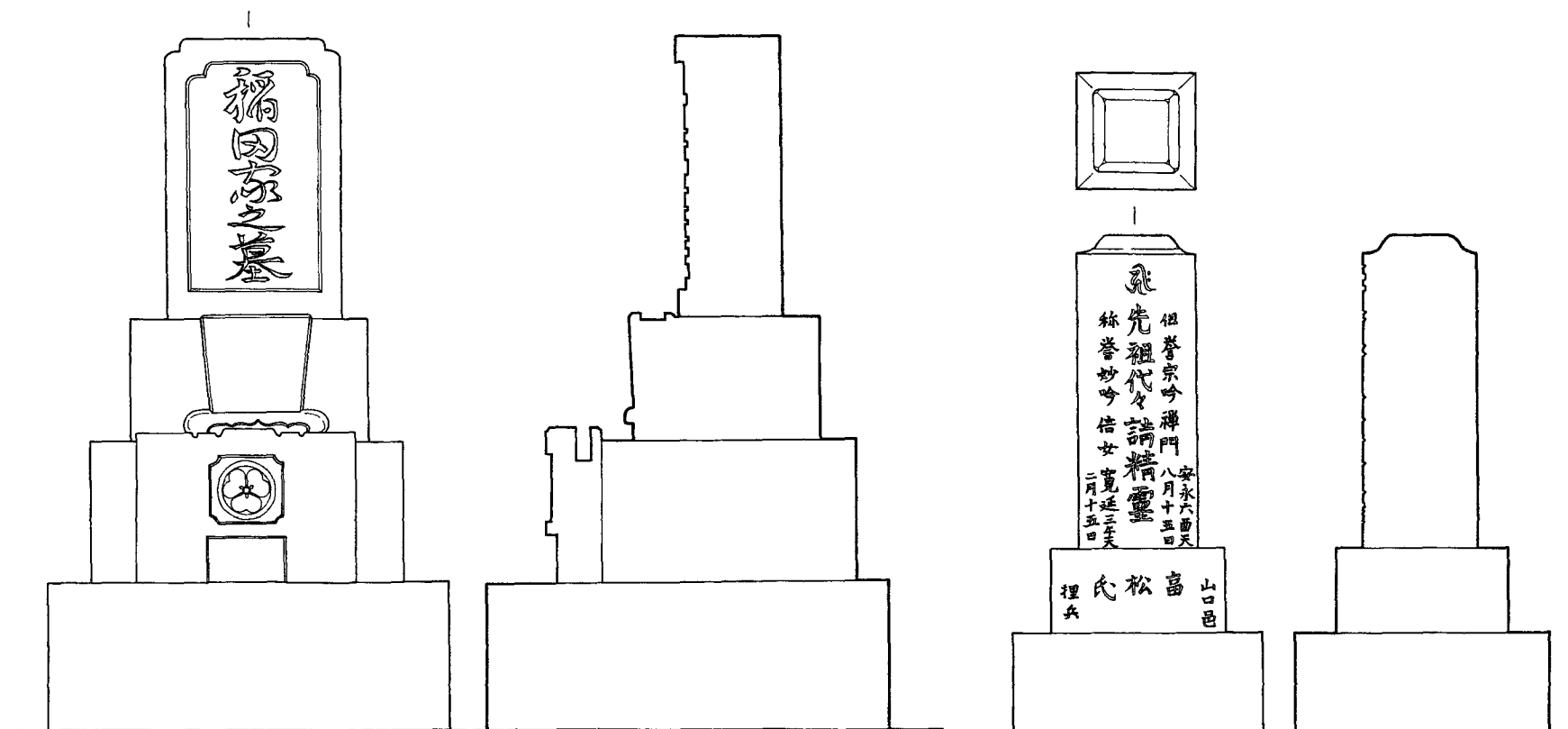

1 橢形 (古南B-4, 昭和二十年:1945)

2 角台頭角柱 (古南C-2, 安永九年:1780)

0 1/15 1m

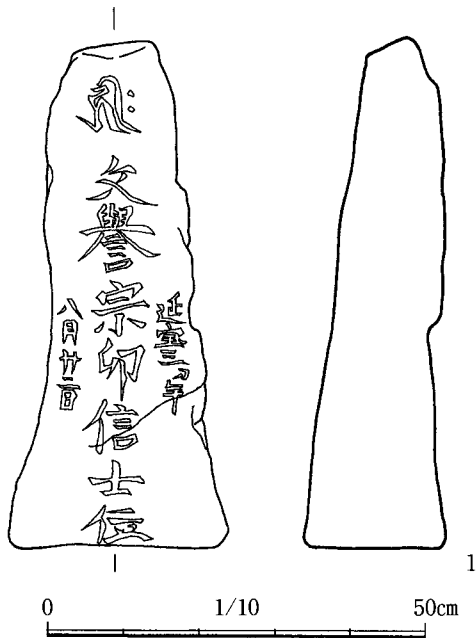

1 不定形 (古北M-18, 延宝三年:1675)
2 石製鳥居 (墓地入口)

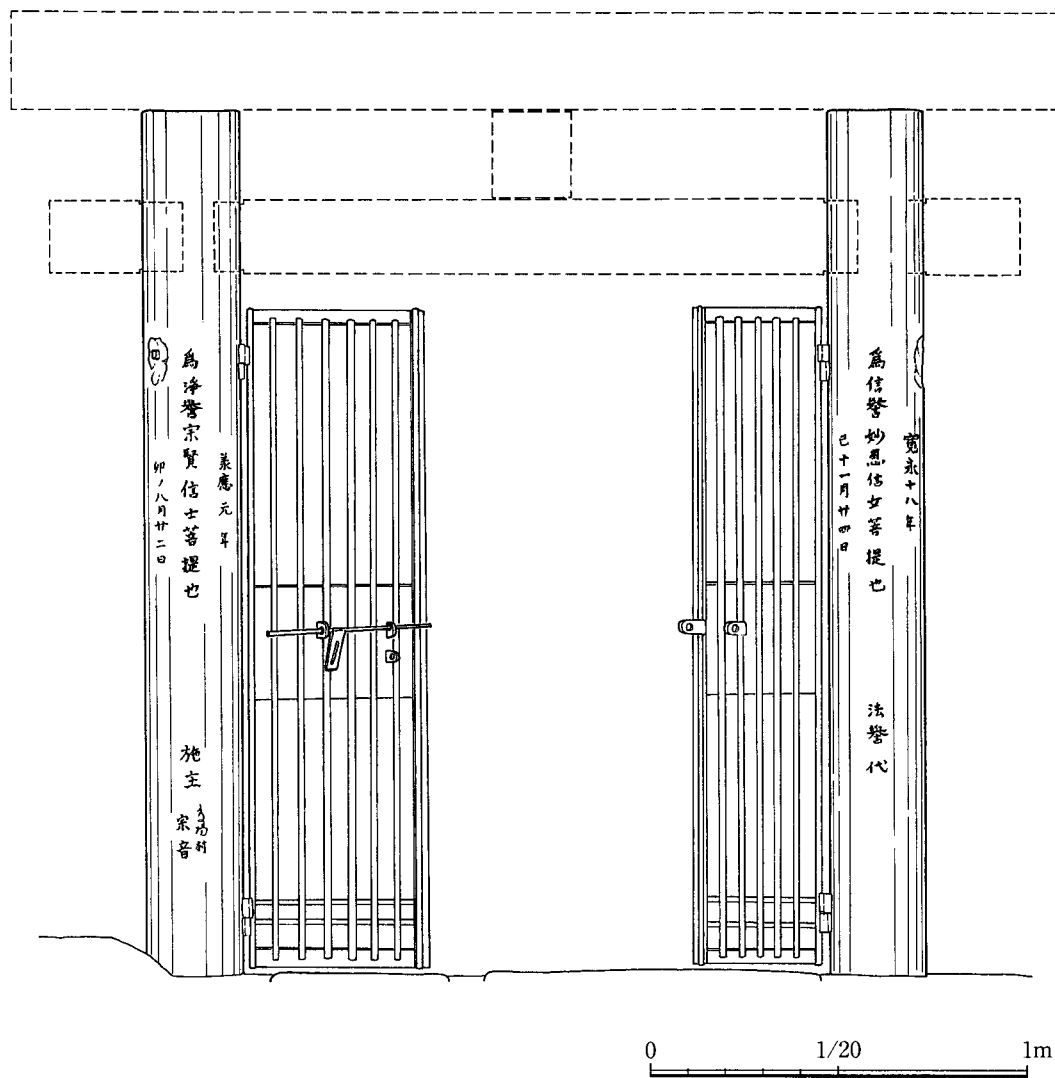

図版 75 平岡極楽寺墓地 石塔 (10)

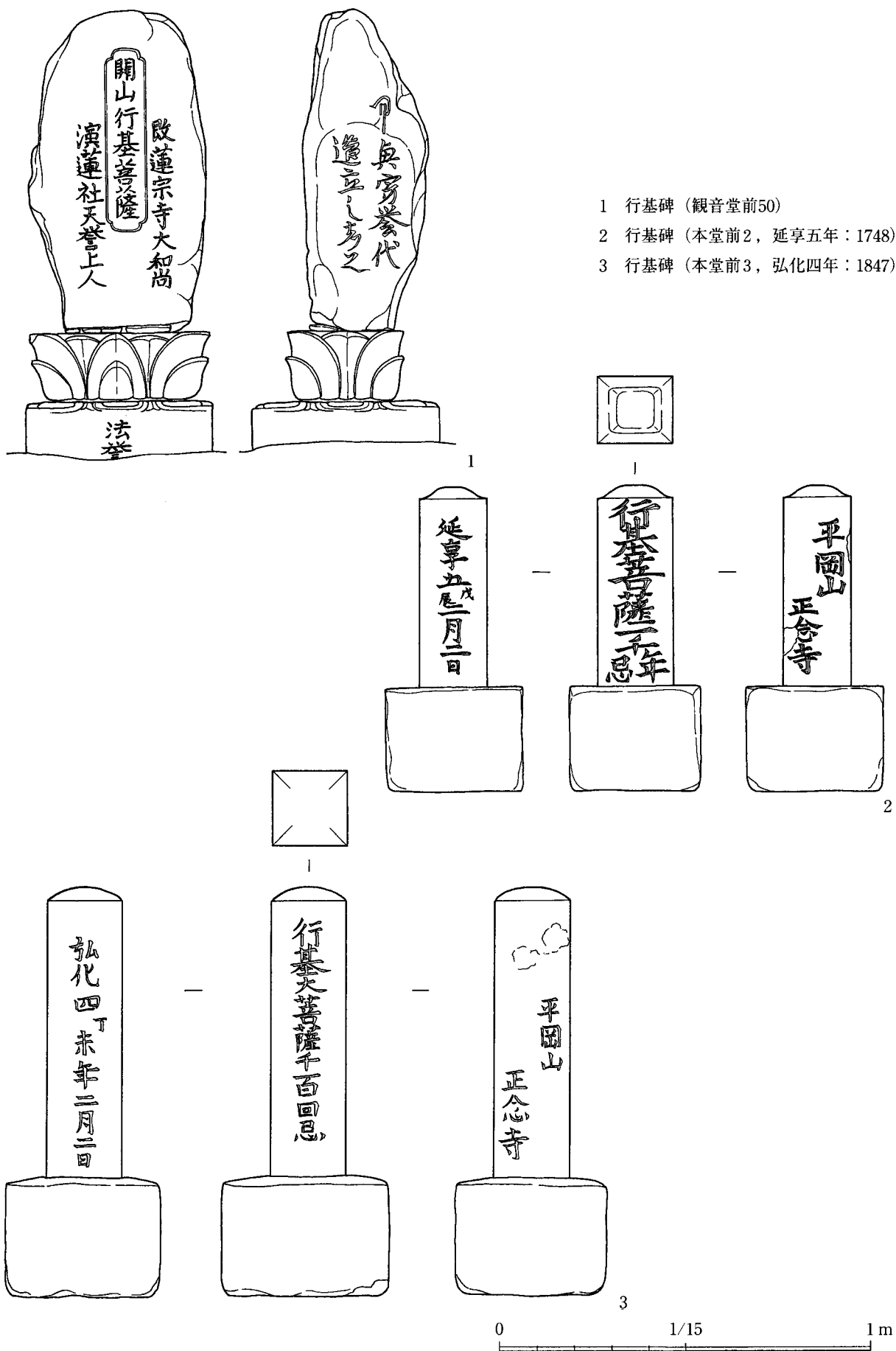

- 1 行基碑（観音堂前50）
- 2 行基碑（本堂前2，延享五年：1748）
- 3 行基碑（本堂前3，弘化四年：1847）

図版 76 平岡極楽寺墓地 石塔 (1)



图版 77 中山念仏寺墓地 全体図

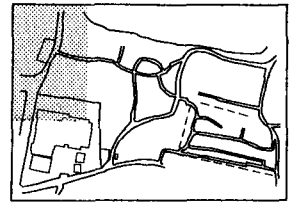

图版 78 中山念仏寺墓地 (1)



図版 79 中山念仏寺墓地 (2)

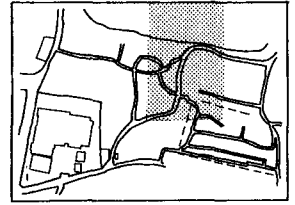

図版 80 中山念仏寺墓地 (3)

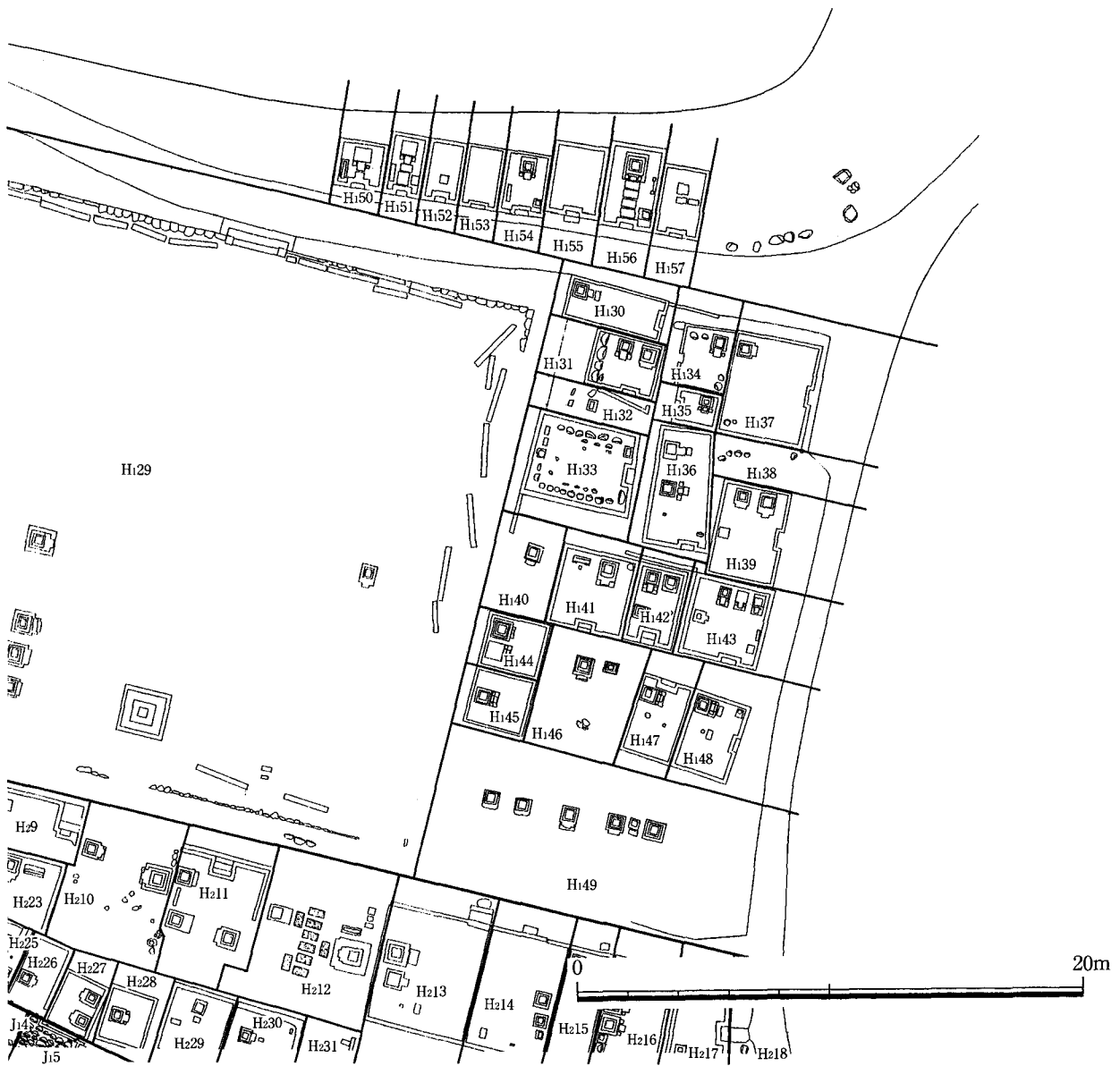
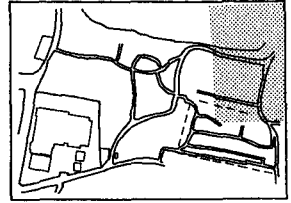

図版 81 中山念仏寺墓地 (4)



图版 82 中山念仏寺墓地 (5)



图版 83 中山念仏寺墓地 (6)

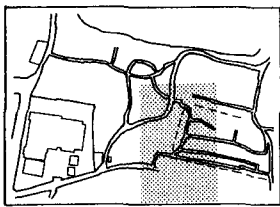

図版 84 中山念仏寺墓地 (7)



图版 85 中山念仏寺墓地 (8)

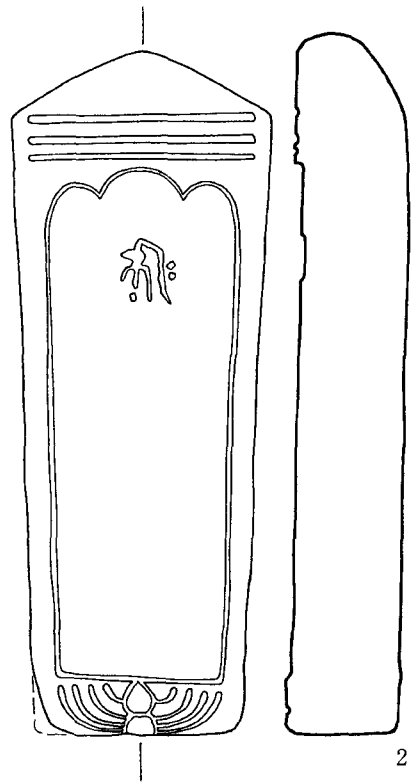
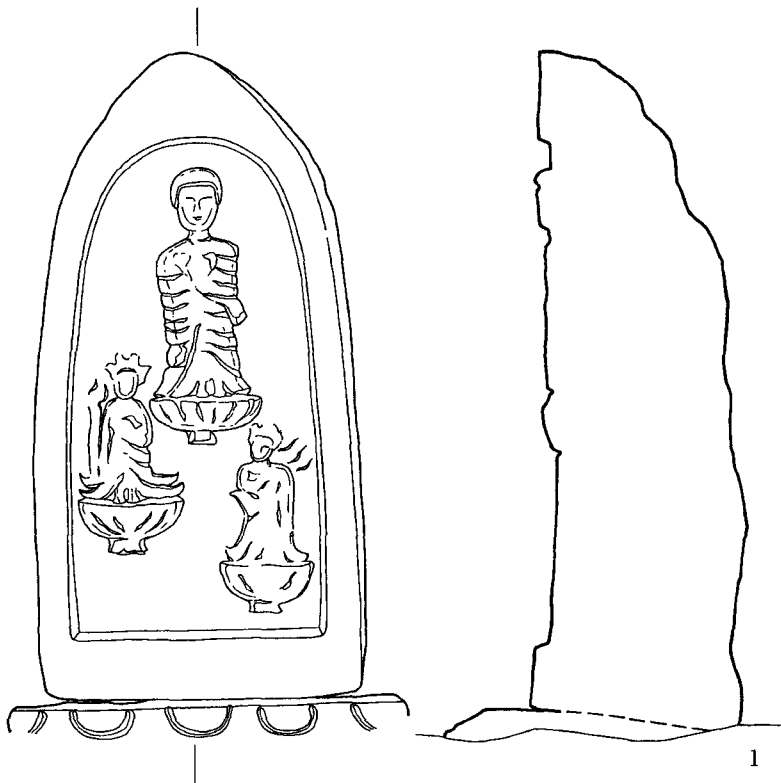

- 1 有像舟形 (K-11-8)
- 2 板碑形 (G-52-48)
- 3 有像舟形 (F-43-36, 享保二年：1717)

0 1/10 50cm

图版 86 中山念仏寺墓地 石塔 (1)

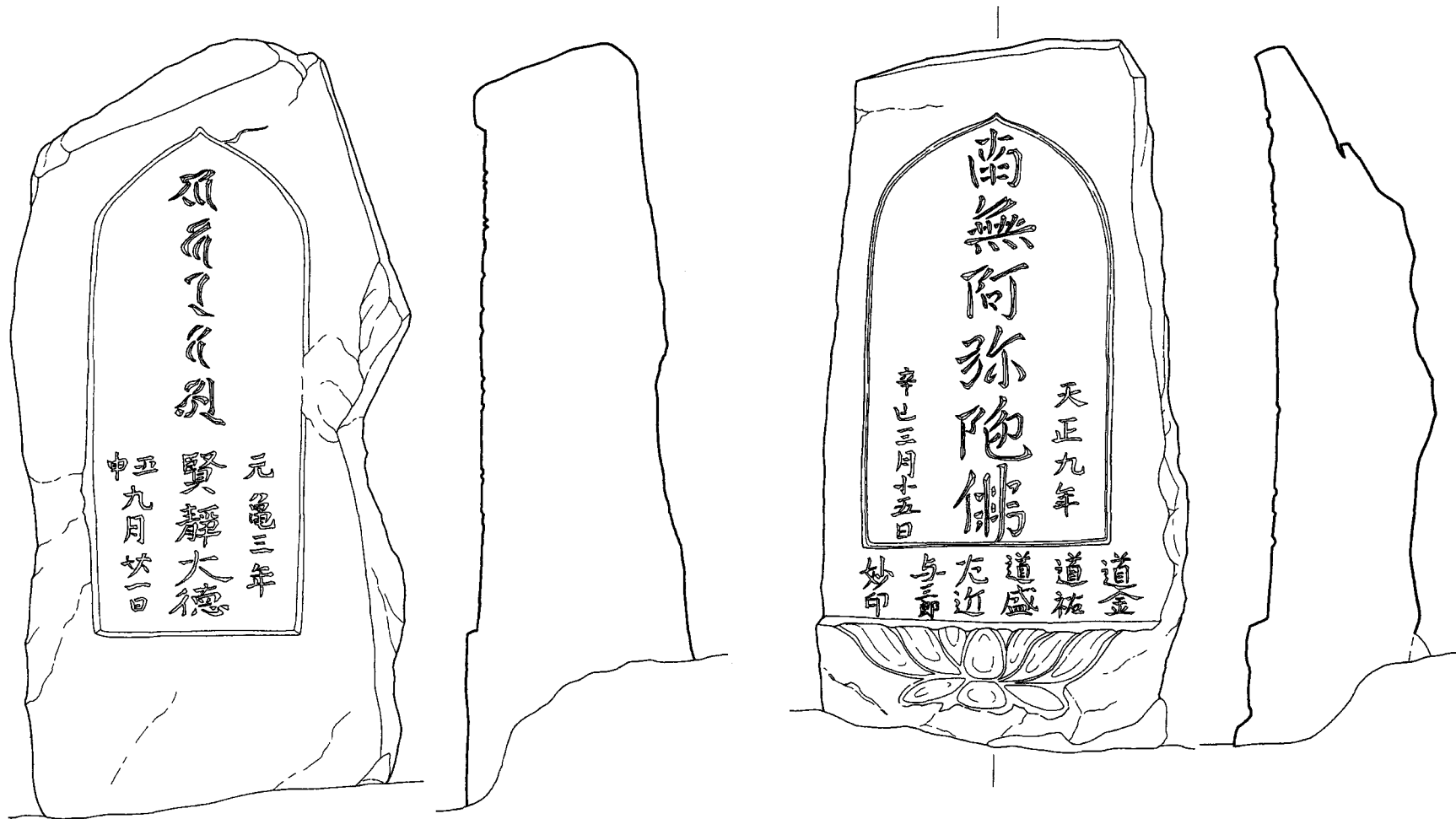

1 不定形 (K-13-17, 元龜三年：1572)

2 不定形 (K-9-17, 天正九年：1581)

0 1/10 50cm

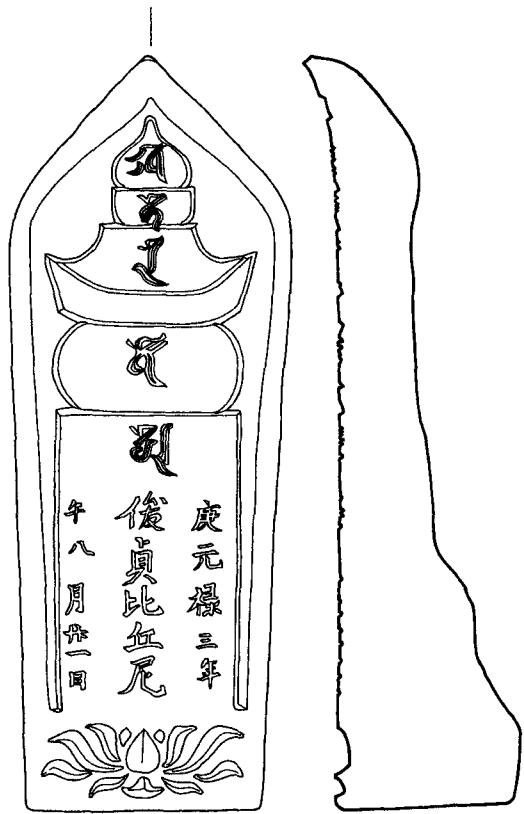

1 背光五輪塔 (J3-25-5, 元禄三年: 1690)

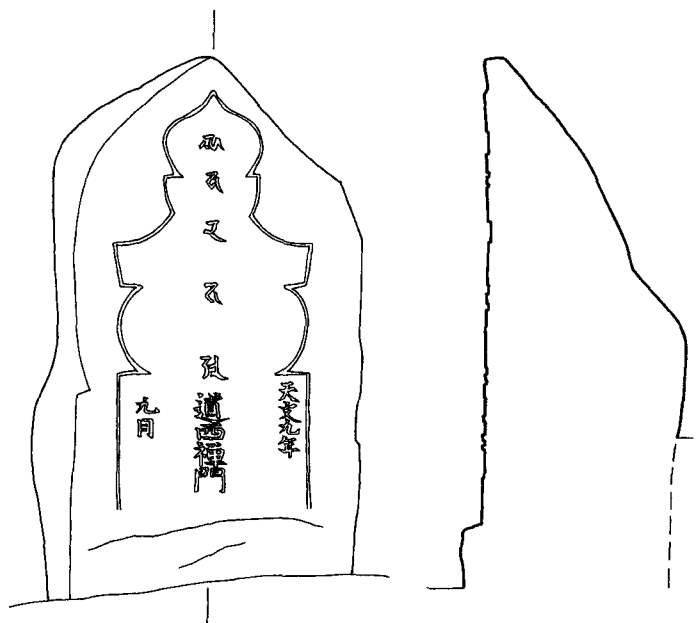

2 不定形五輪塔 (K-3-32, 天文九年: 1540)



3 不定形連立五輪塔 (B-71-8, 延宝元年: 1673)

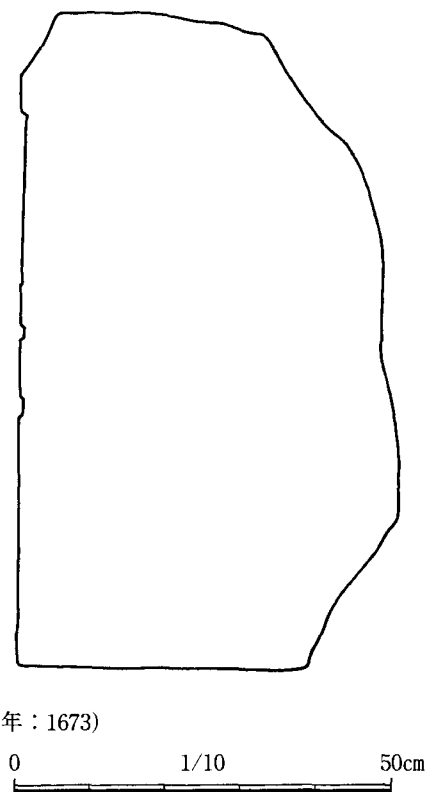

0 1/10 50cm

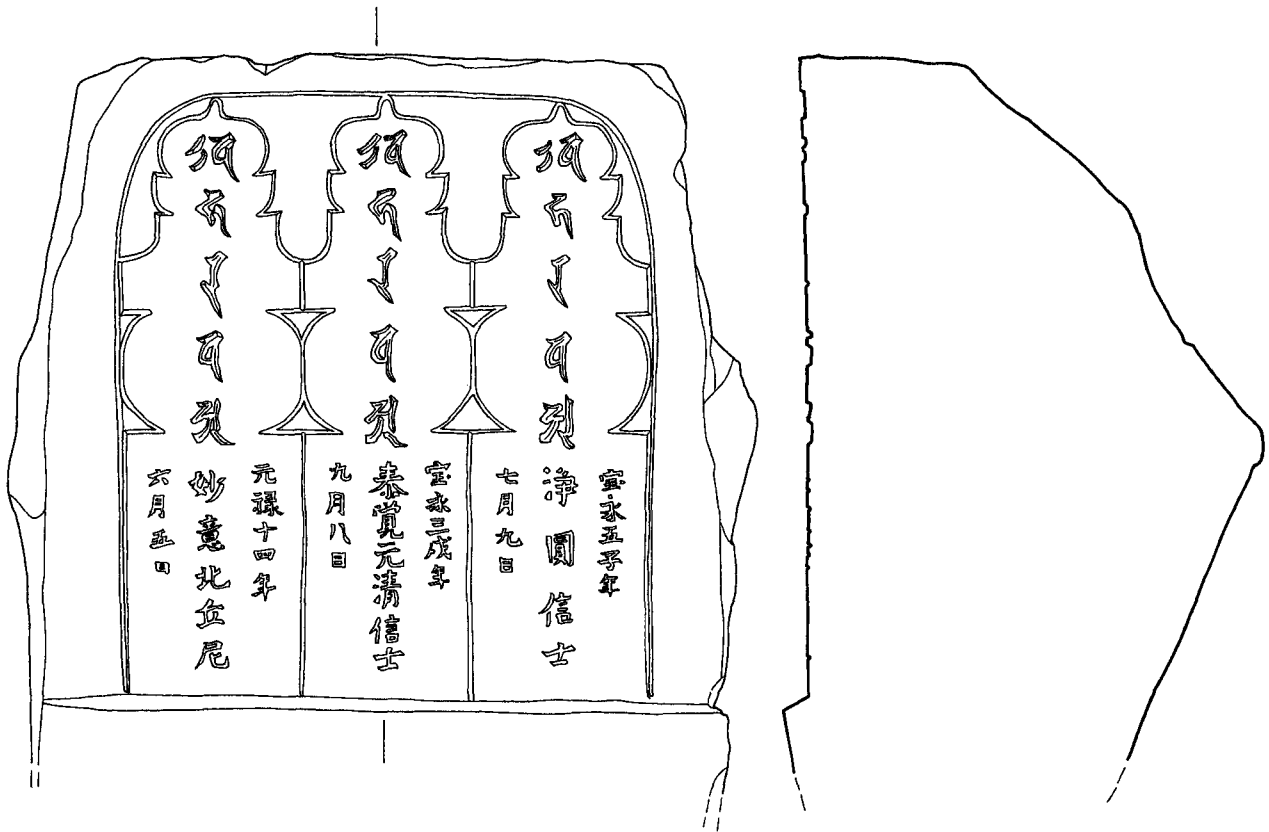

1 不定形三連五輪塔 (B-71-9, 宝永五年：1708)

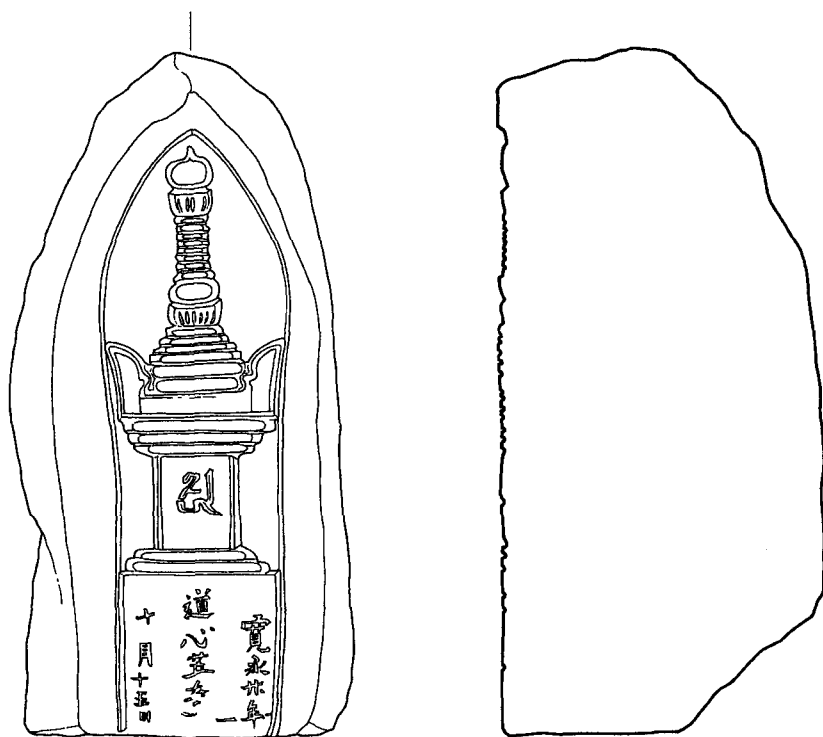

2 背光宝篋印塔 (K-11-9, 寬永二十年：1643)

0 1/10 50cm

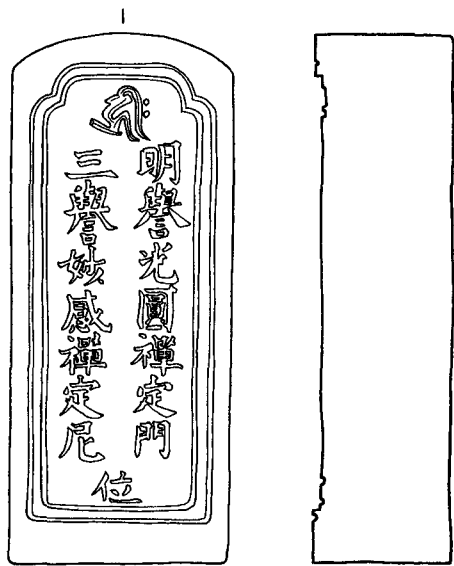

1 櫛形 (G-72-30, 慶応三年: 1867)

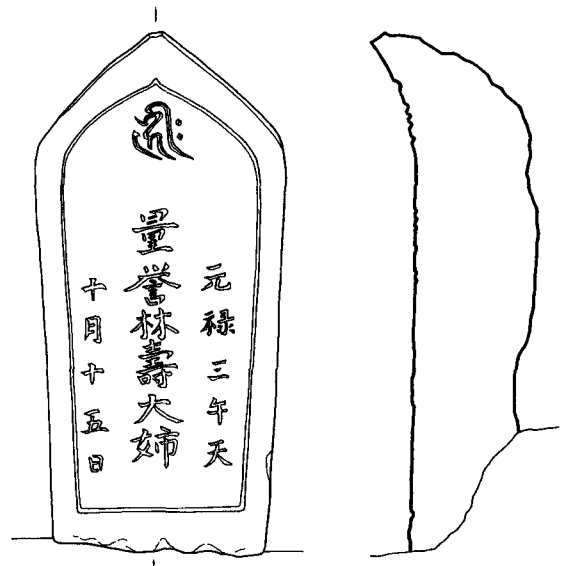

4 舟形 (B-70-25, 元禄三年: 1690)

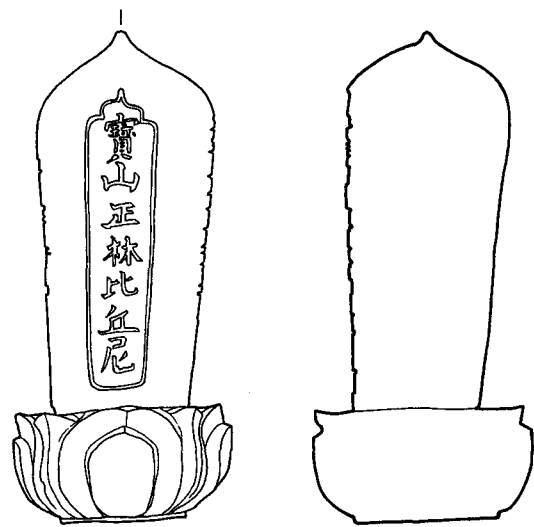

2 無縫塔 (G-70-24, 寛政十一年: 1799)

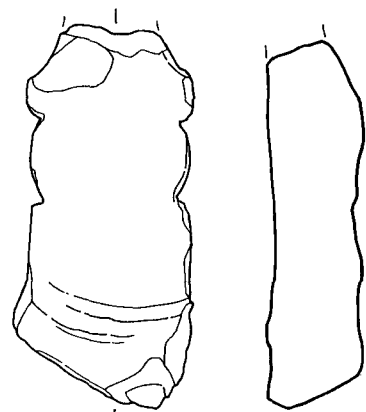

5 半截五輪塔 (A-1-23)

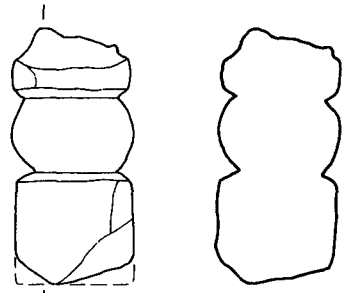

6 一石五輪塔 (C-87-23)

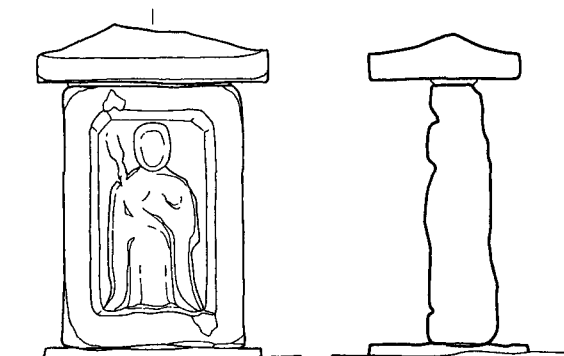

3 箱仏 (J₂-14-32)

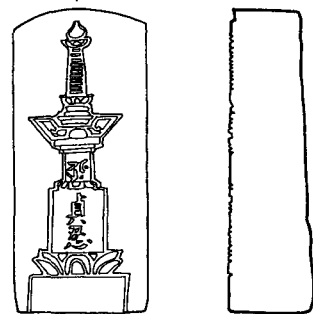

7 櫛形宝篋印塔 (G-72-6, 宝暦十三年: 1763)

0 1/10 50cm

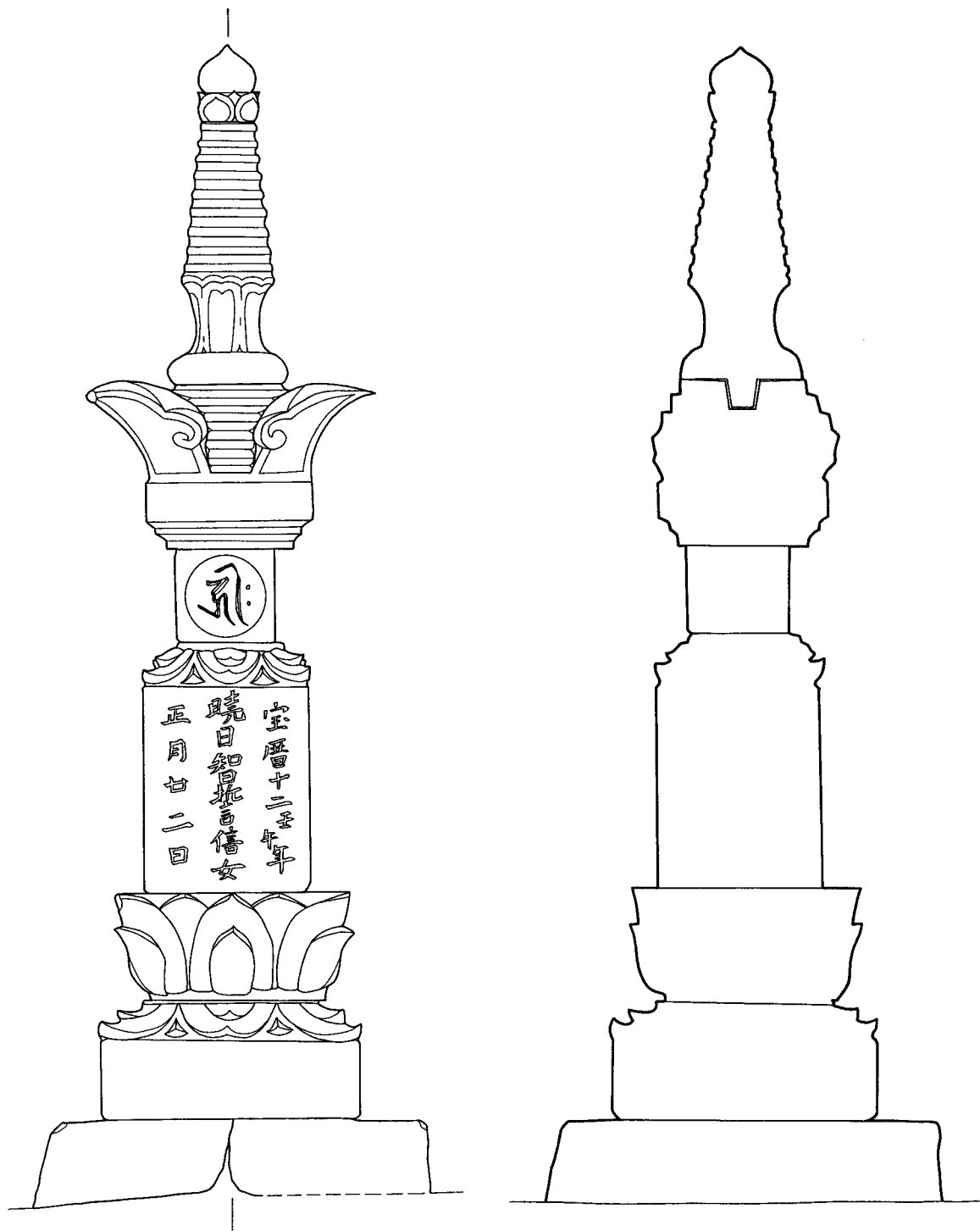

1 宝篋印塔 (G-56-15, 天明五年: 1785)

0 1/10 50cm

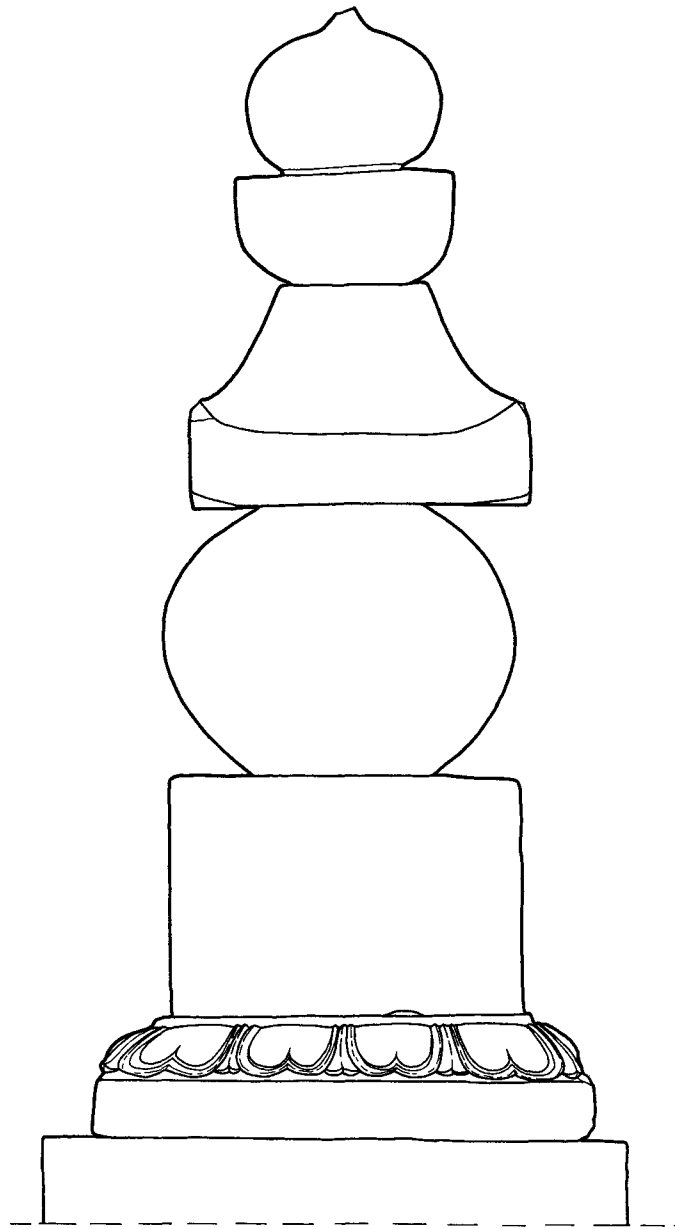

1 別石五輪塔 (A-1-20)

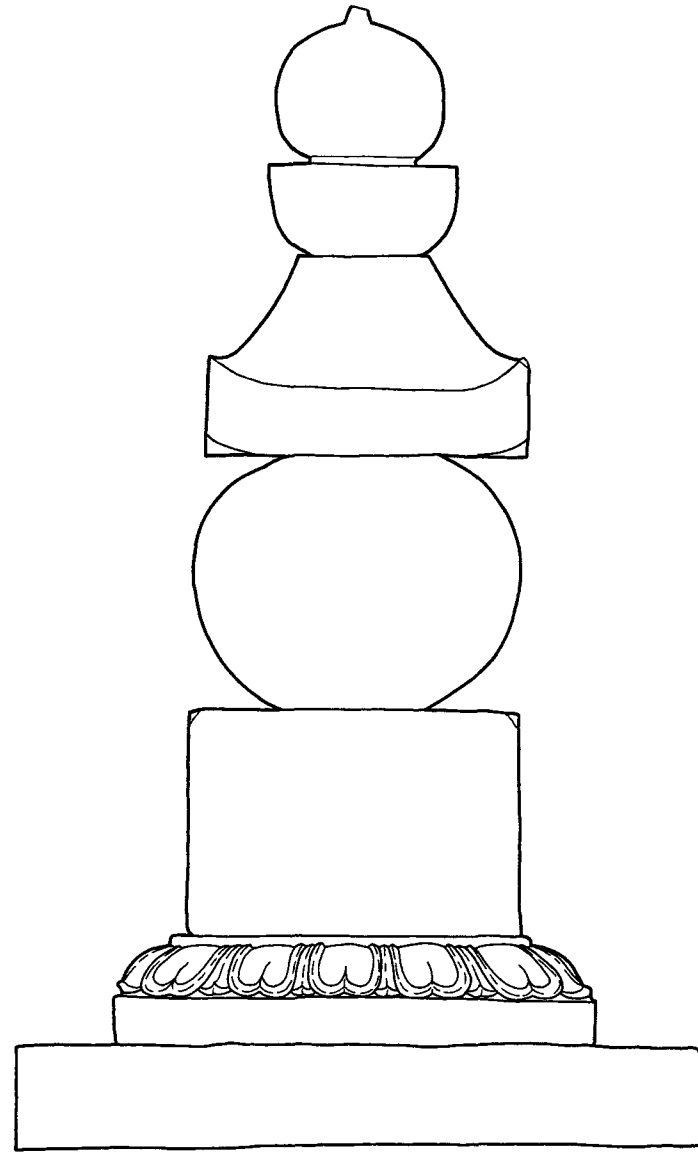

2 別石五輪塔 (柳本墓地脇)

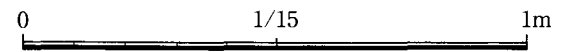

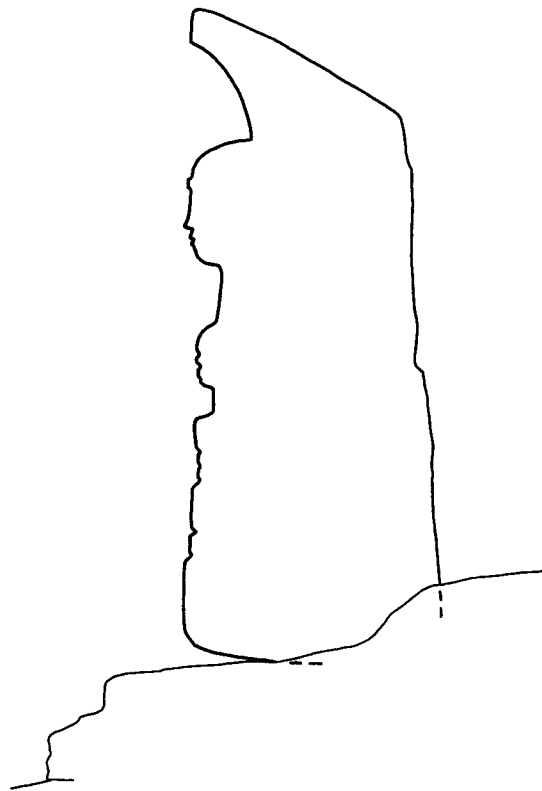
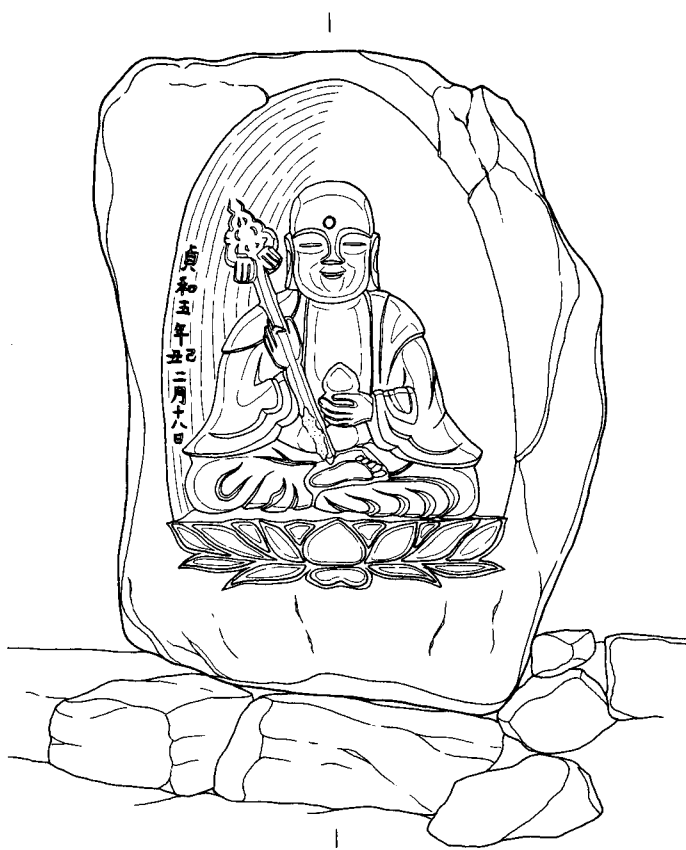

1

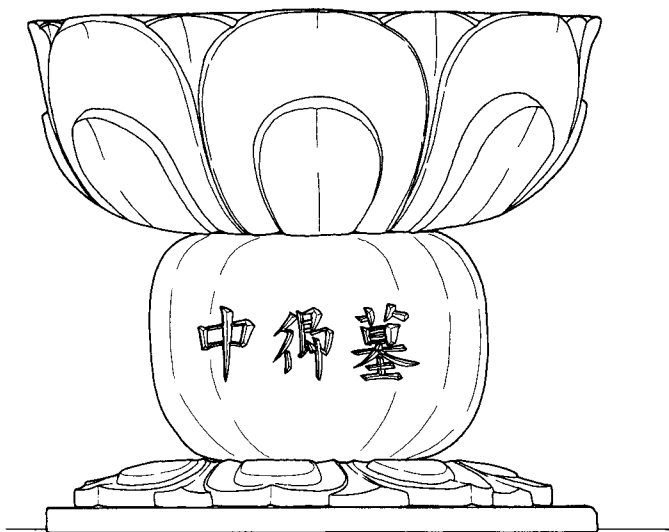

2

- 1 有像自然石 (本堂脇-12, 貞和五年: 1349)
- 2 棺台 (I-12-2, 文化十一年: 1814)

0 1/10 50cm

図版 94 中山念仏寺墓地 石塔 (9)

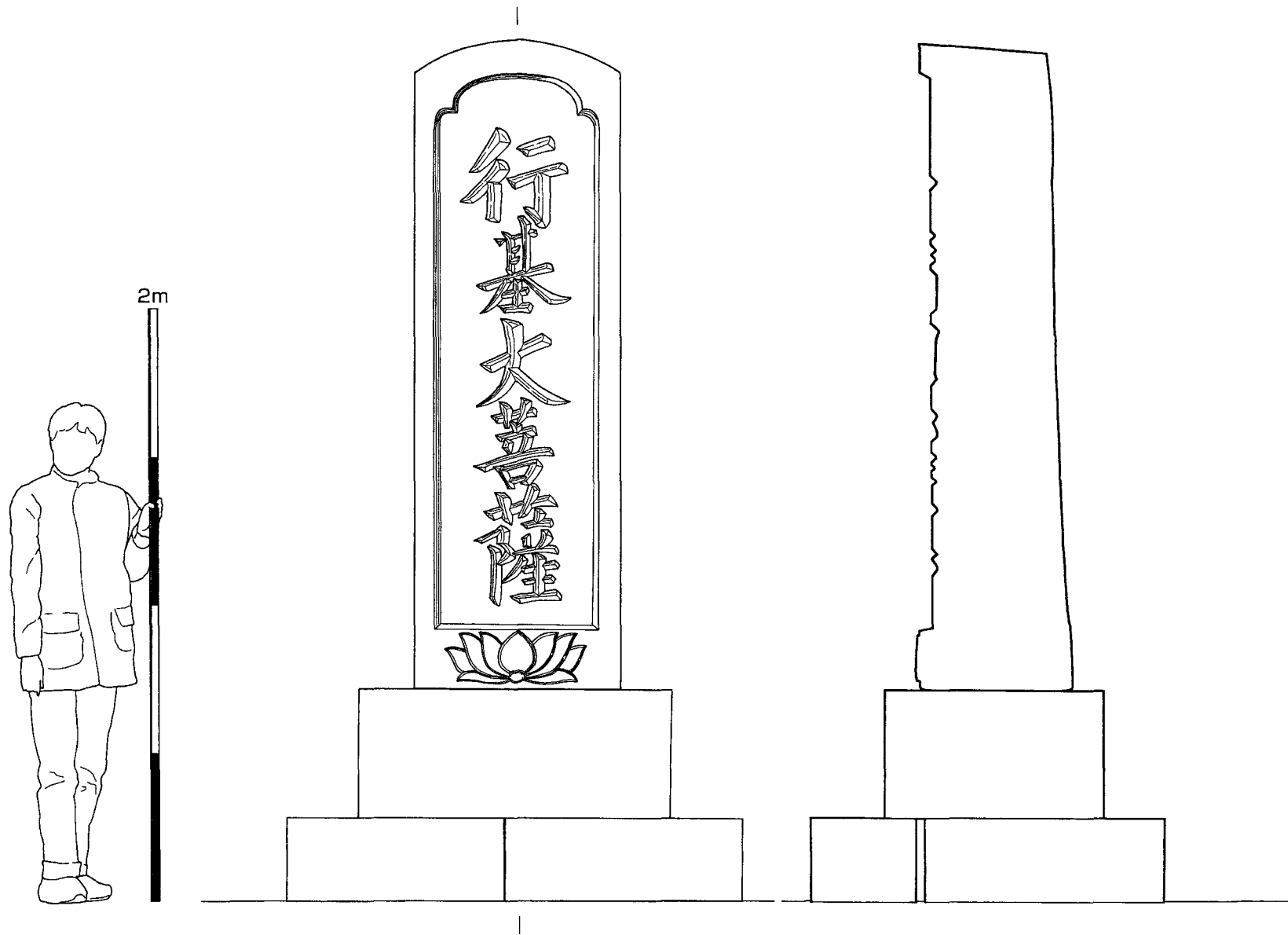

1 櫛形 (行基碑) (I-12-1, 明和二年: 1765)

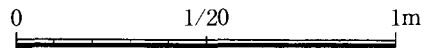

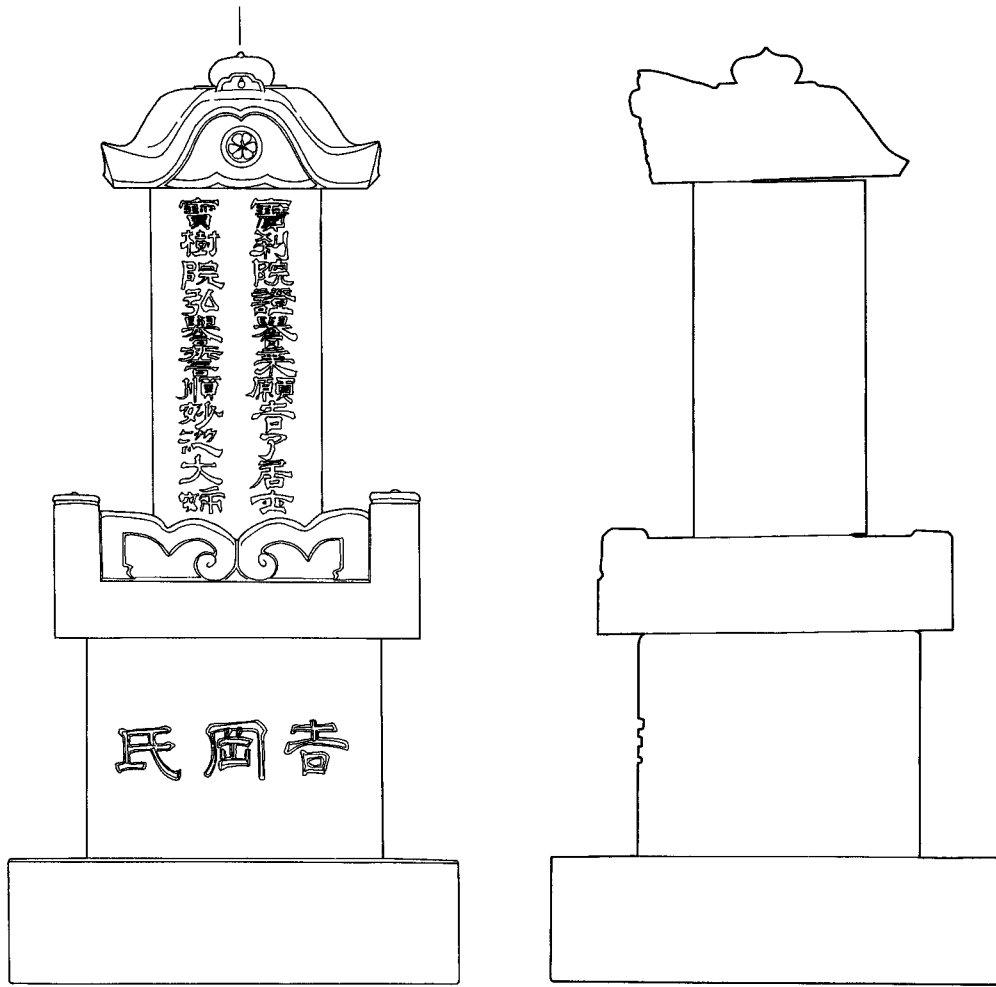

1 笠塔婆 (G-65-2, 明治三十四年:1901)

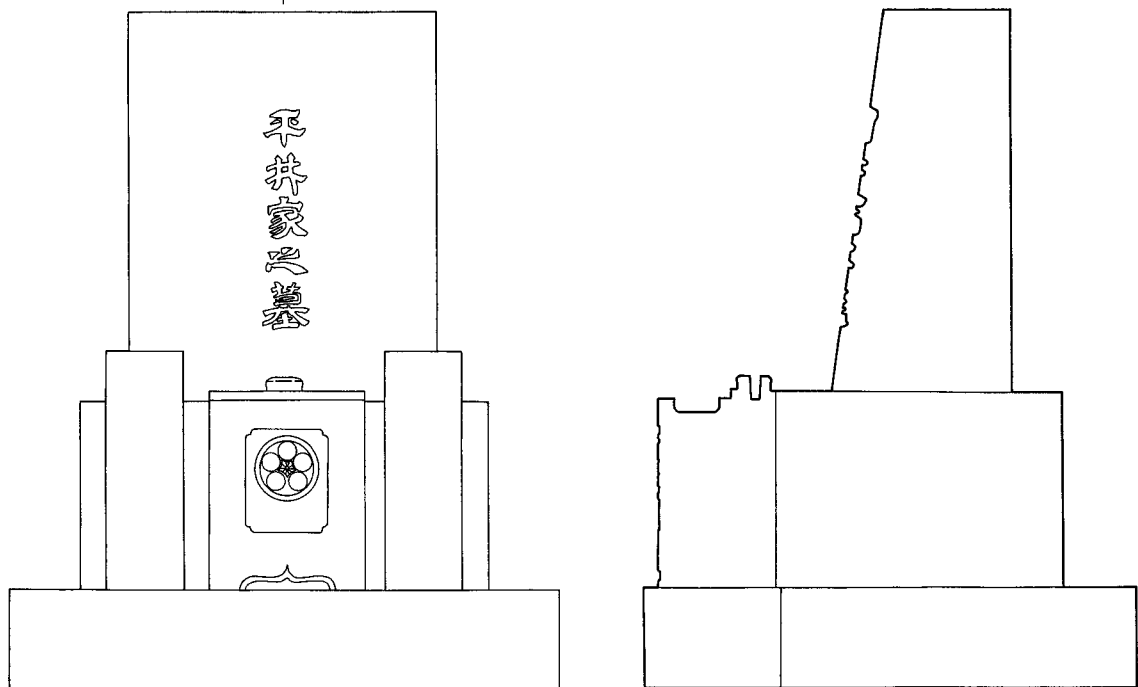

2 横長形 (A-23-1, 昭和四十一年:1966)

0 1/15 1m

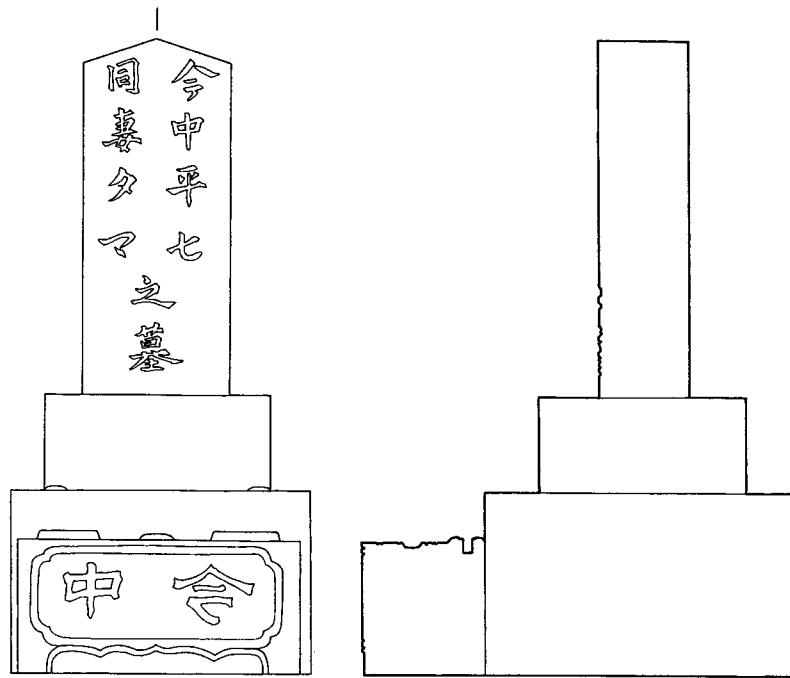

1 駒形 (I-91-2, 明治二十二年: 1889)

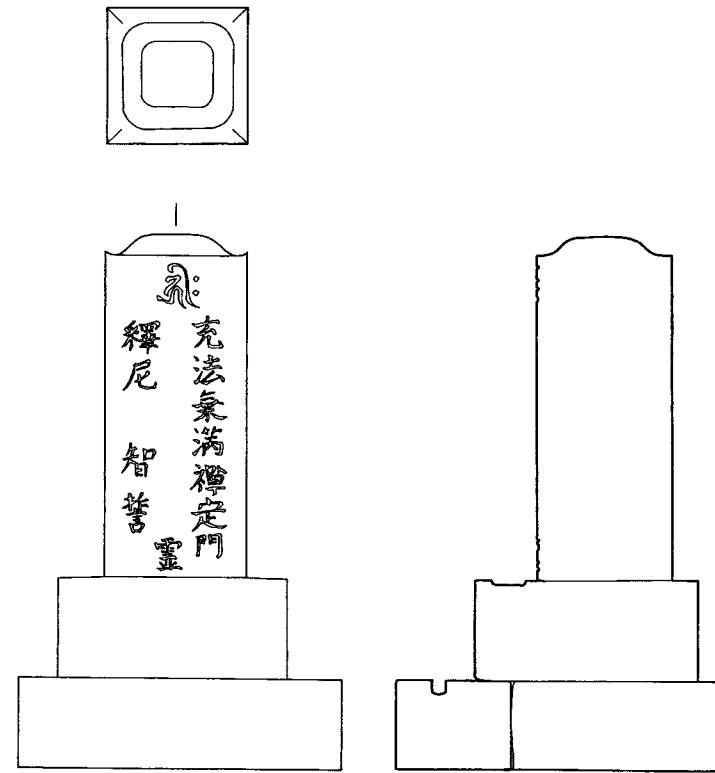

2 角台頭角柱 (E-7-10, 嘉永元年: 1848)

0 1/15 1m

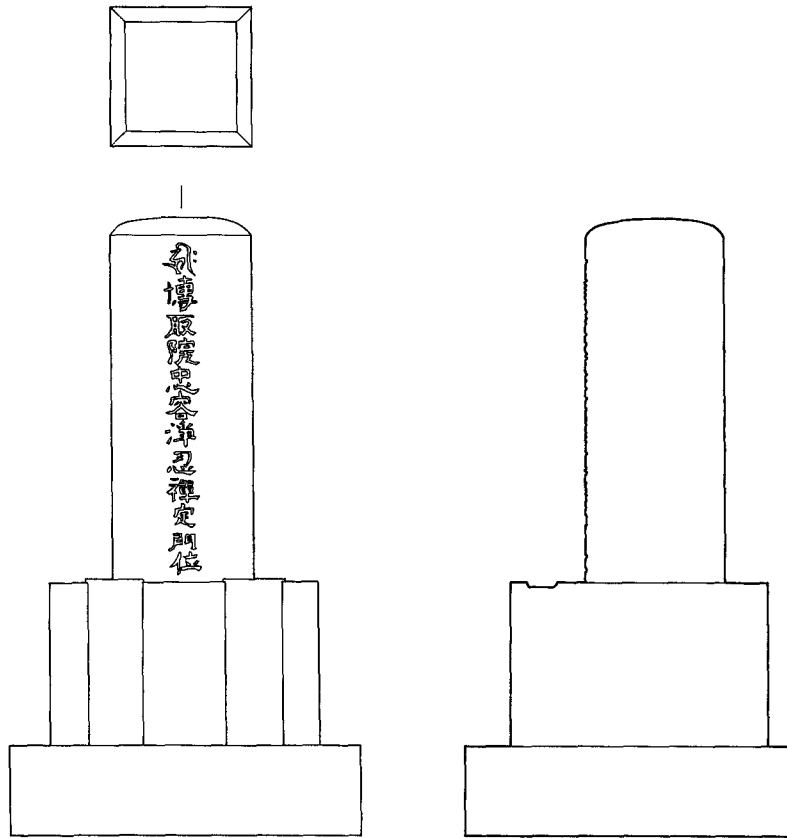

1 平頭角柱 (E-1-24, 明治四十年:1907)

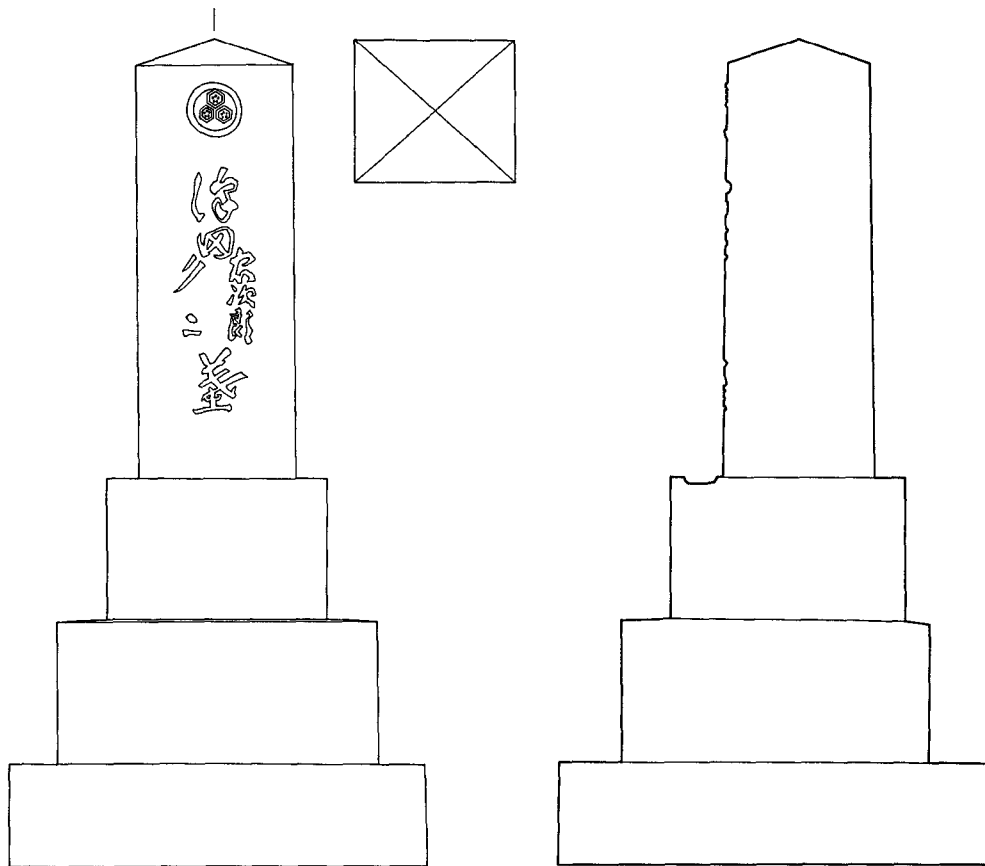

2 尖頭角柱 (F-61-3, 大正六年:1917)

0 1/15 1m

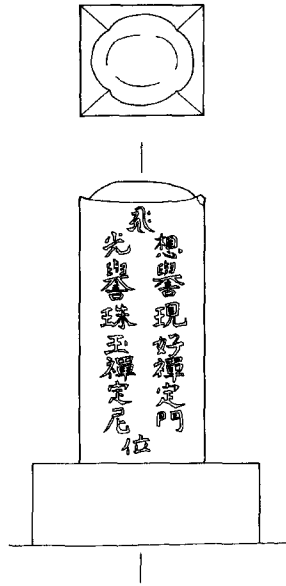

1 丘状頭角柱 (J4-15-9, 明治四十三年:1910)

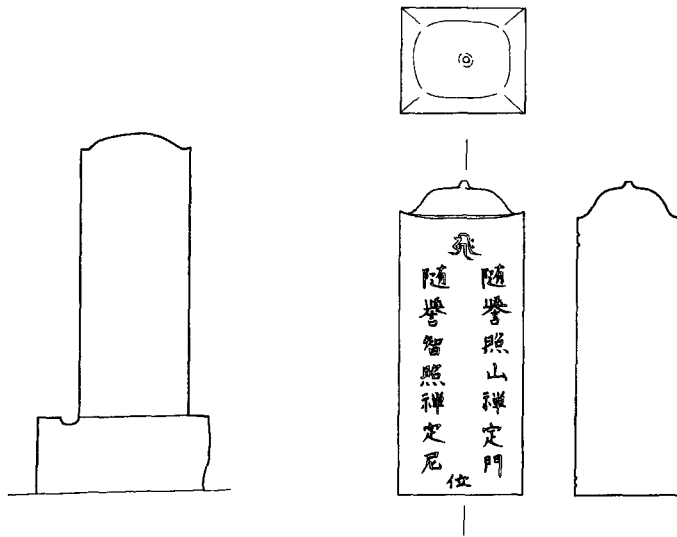

2 有突起角柱 (H1-33-19, 慶応四年:1868)

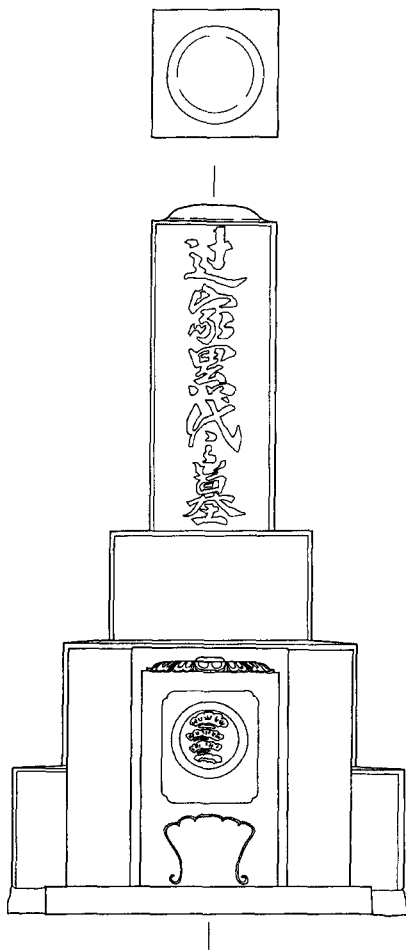

3 丸台頭角柱 (F-7-1, 昭和三年:1928)

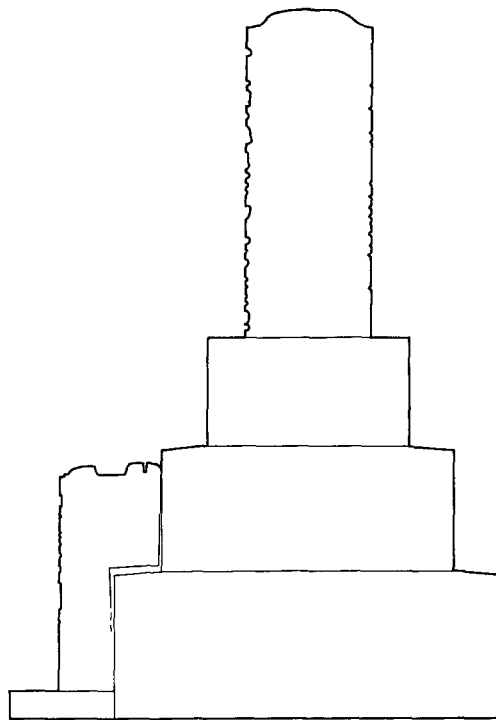

0 1/15 1m



1 入谷墓地全景（北から）



2 入谷墓地全景（南東から）



3 石塔と埋墓との関係（北西から）



4 埋墓全景（北西から）



5 「金兵衛さん」全景（南から）



6 「金兵衛さん」全景（南西から）



7 「金兵衛さん」全景（北東から）



8 別区の石塔石材



1 I-1 (「金兵衛さん」)

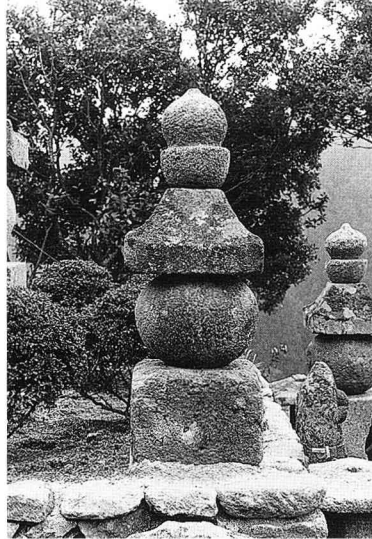

2 I-4



3 I-21



4 I-18



5 I-80

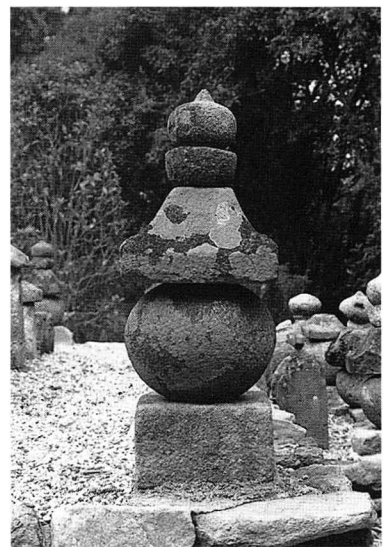

6 I-73



7 I-65



8 I-64



9 I-58

写真 2 入谷墓地の石塔 (1)



1 I-11



2 I-10



3 I-9



4 I-55



5 I-33



6 I-53



7 I-47, 48



8 I-42

写真 3 入谷墓地の石塔 (2)



1 A-1



2 A-7



3 A-10



4 A-13, 14



5 B-1

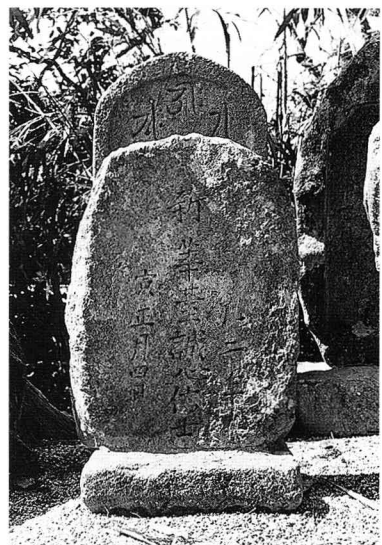

6 B-4



7 B-7



8 B-9



9 B-10

写真 4 入谷墓地の石塔 (3)



1 C-2



2 C-3

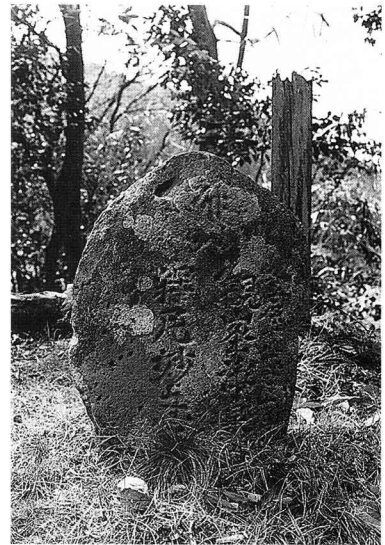

3 C-9



4 C-11



5 D-12



6 D-13



7 E-8~12 (正面右から)



8 E-24~26 (五輪塔と奥の箱仏)

写真 5 入谷墓地の石塔 (4)



1 E-27



2 E-29



3 E-32



4 F-3



5 F-4, 5 (右から)



6 F-6, 7 (右から)



7 F-8



8 F-10



9 G-1

写真 6 入谷墓地の石塔 (5)



1 G-2



2 G-13,14 (右から)

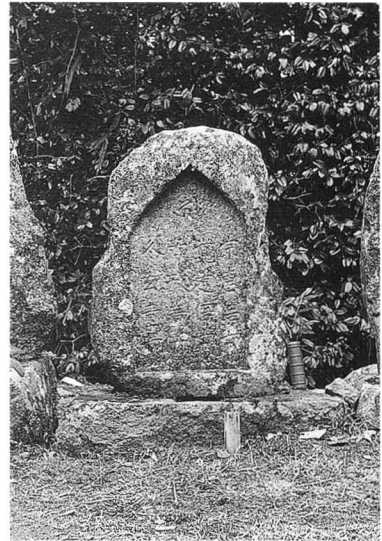

3 G-16



4 G-17



5 G-19



6 G-28



7 G-35



8 G-38,39 (右から)



9 G-41

写真 7 入谷墓地の石塔 (6)



1 G-43



2 G-44



3 G-45

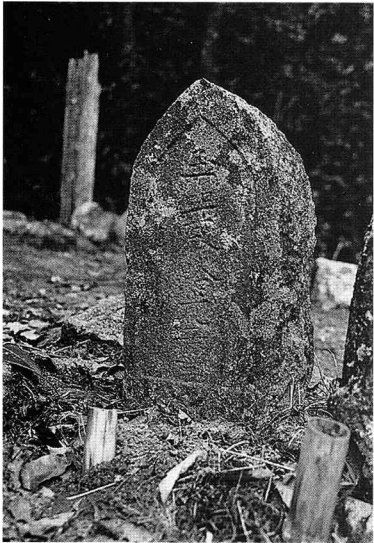

4 G-46



5 H-3



6 H-11, 12 (右から)



7 H-7~10 (右から)



8 H-15~18 (右から)

写真 8 入谷墓地の石塔 (7)



1 ドサカ墓地全景 (北から)



2 A区全景



3 A-3, 5, 6 (奥左から), 2, 4 (手前左から)



4 A-10~14 (左から)



5 A-9

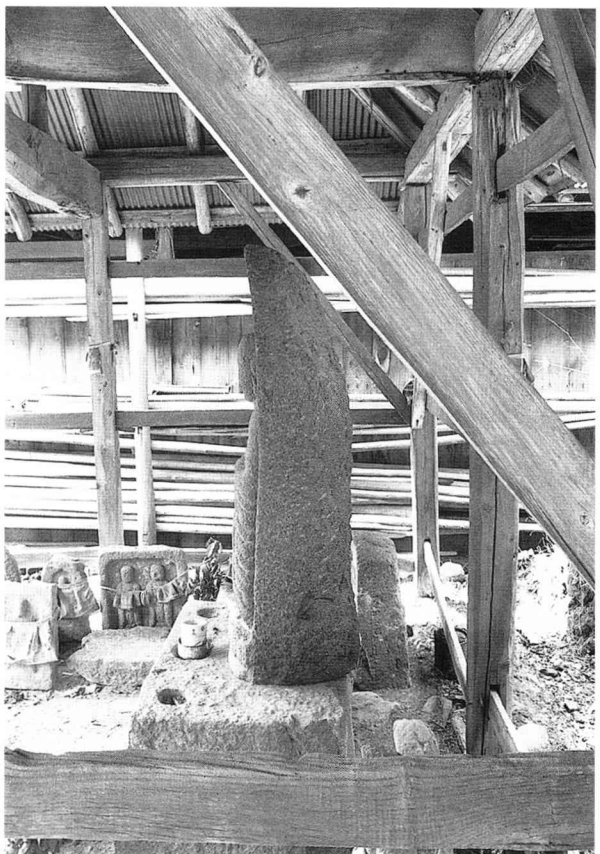

6 A-9

写真 9 ドサカ墓地の石塔 (1)



1 B区全景



2 B-1~4 (左から)



3 B-7~10 (奥左から), 12,13 (手前右から)



4 C区全景



5 D区全景



6 D区



7 D区



8 D区

写真10 ドサカ墓地の石塔(2)

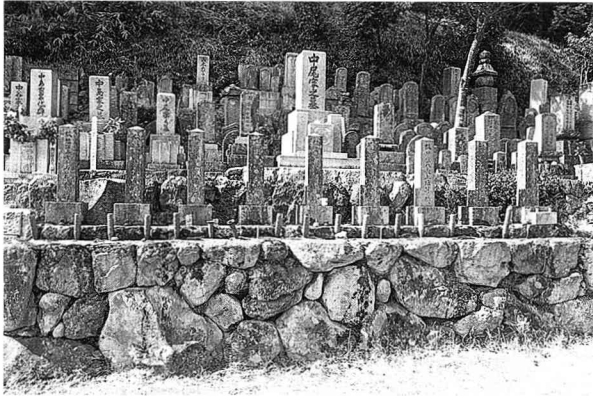

1 E区



2 F区



3 G区



4 H区



5 I区



6 J区



7 K区



8 L区

写真11 ドサカ墓地の石塔 (3)



1 M区



2 Na1区



3 Nb区



4 Nc区



5 O区



6 Pa1区



7 Pb区



8 Pc区

写真12 ドサカ墓地の石塔(4)



1 Q区



2 Q区



3 Ra区



4 Rb区



5 S区



6 T区



7 U区



8 埋葬への道

写真13 ドサカ墓地の石塔(5)



1 春明院全景



2 春明院



3 春明院



4 埋墓（左）と春明院



5 A区



6 Ba区



7 Bb区



8 Bb区

写真 14 春明院墓地の石塔 (1)



1 Bb-8 「天正四年：1576」



2 Bb-13 「永禄久丙寅年：1563」



3 Bc区



4 Bd区



5 Be区



6 C区

写真 15 春明院墓地の石塔 (2)



1 C区



2 C区



3 C区



4 D区



5 D区



6 E区



7 E区



8 H区

写真 16 春明院墓地の石塔 (3)



1 ムシロデン墓地全景



2 ムシロデン墓地石塔

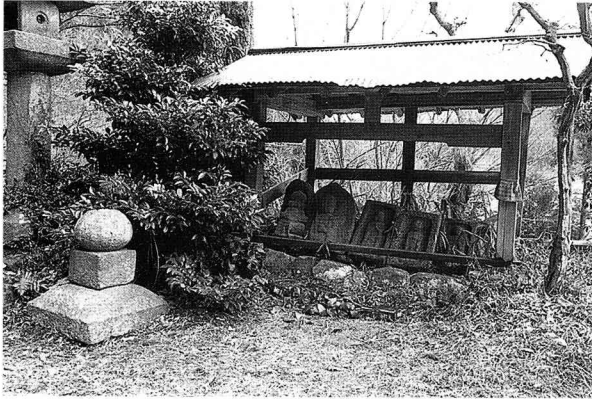

3 成福寺境内石塔



4 城福寺辻堂石塔



5 仏法寺



6 仏法寺境内永禄年銘地藏立像



7 ジョインタニ全景



8 ジョインタニ石塔



写真 18 平岡極楽寺墓地全景

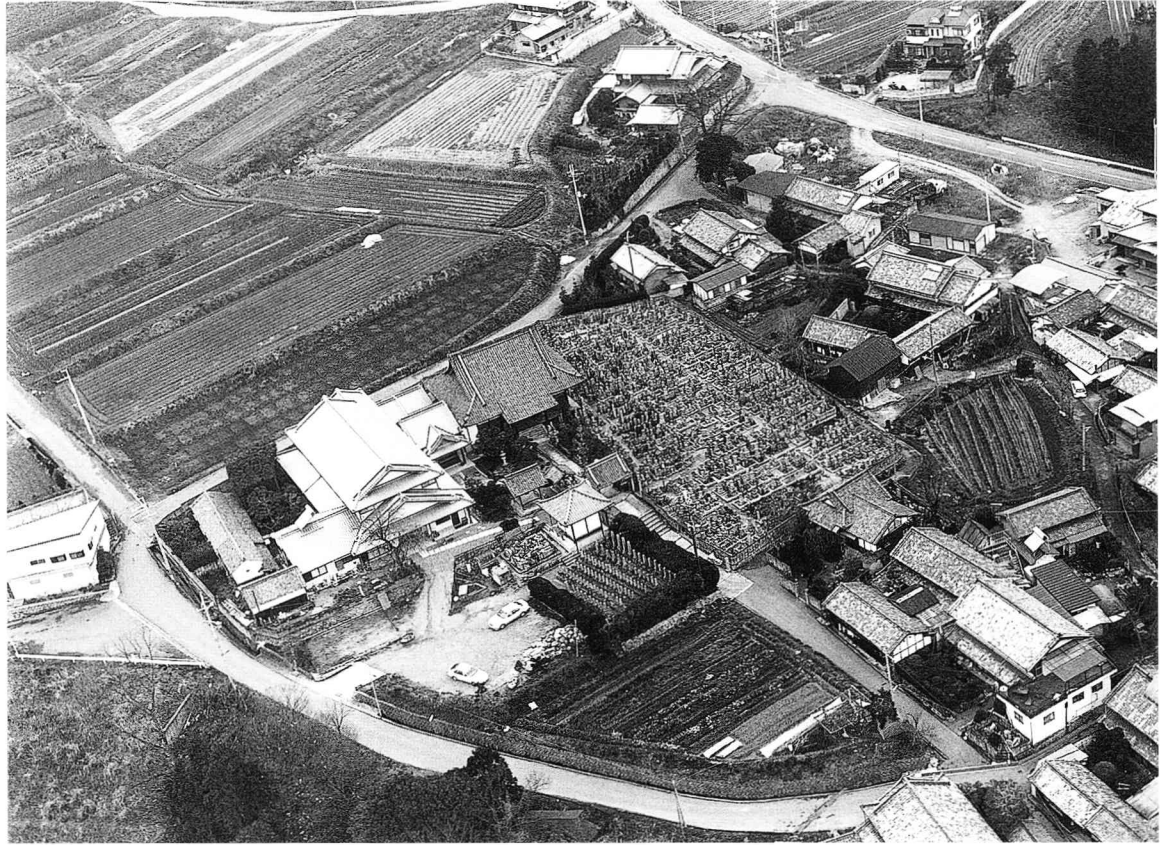

1 平岡極楽寺墓地全景（俯瞰）



2 平岡極楽寺参道



3 極楽寺境内



4 六地藏



5 墓地入口（石製鳥居）

写真19 平岡極楽寺と墓地景観



1 古墓地区（南西から）



2 新墓地区（東から）



3 新町区画



4 極楽寺歴代住職墓所（古墓西区）



5 無縁墓標群



6 軍人墓

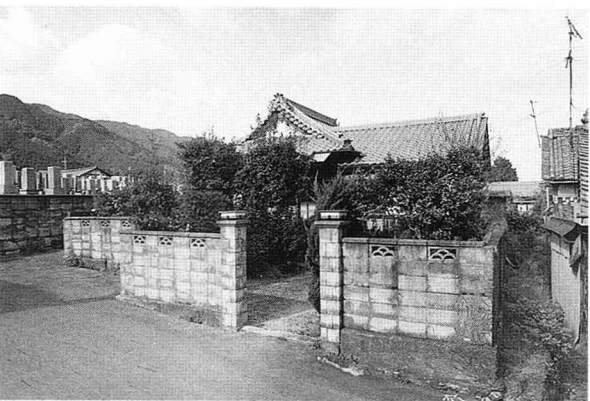

7 千手院



8 観音堂裏墓地（千手院の裏）



1 有像舟形 (古北N-1)



2 有像舟形 (古北I-17)



3 丸彫形 (古北G-17)



4 箱仏 (境内外1)



5 別石五輪塔 (無縁墓標群1)



6 一石五輪塔 (古北B-30)



7 地輪 (無縁墓標群 293)



8 背光五輪塔 (古北F-15)



1 背光宝篋印塔 (脇田A-4)

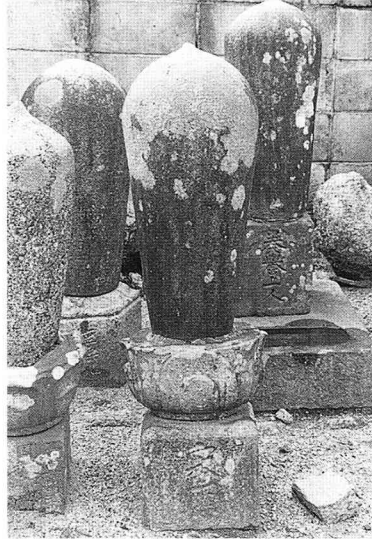

2 無縫塔 (古西17)

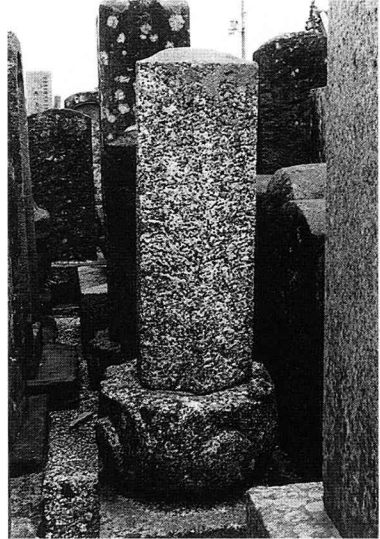

3 六角無縫塔 (古北L-11)



4 板碑形 (古北G-26)



5 駒形 (古北K-9)

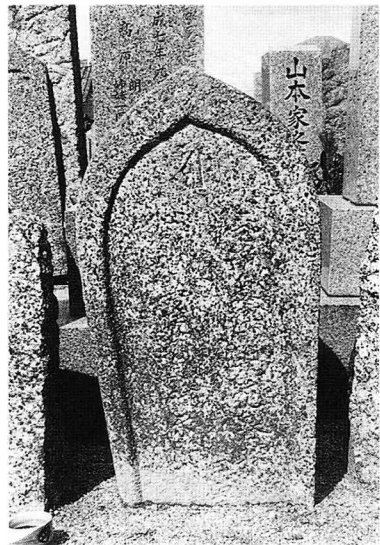

6 舟形 (古南E-3)



7 櫛形 (古北D-13)



8 不定形 (古北M-18)

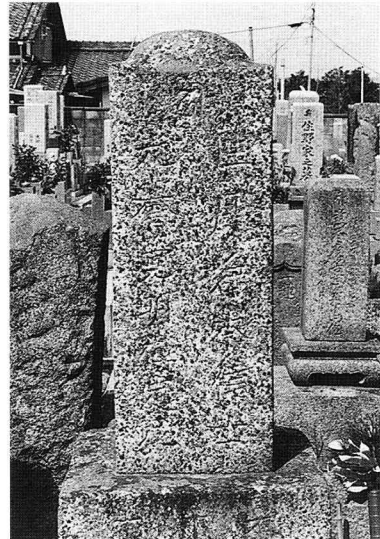

9 丸台頭角柱 (古南D-1)



1 角台頭角柱 (観音堂裏A-6)



2 丘状頭角柱 (古北C-7)



3 平頭角柱 (古南A-5)



4 尖頭角柱 (右側：笛吹F-2)



5 笠塔婆 (古北M-14)



6 円柱 (脇田J-17)



7 行基碑 (観音堂前50)



8 行基碑 (本堂前2)



9 迎え地藏 (極楽寺参道)



写真 24 中山念仏寺墓地全景



1 燈籠山古墳前方部利用状況

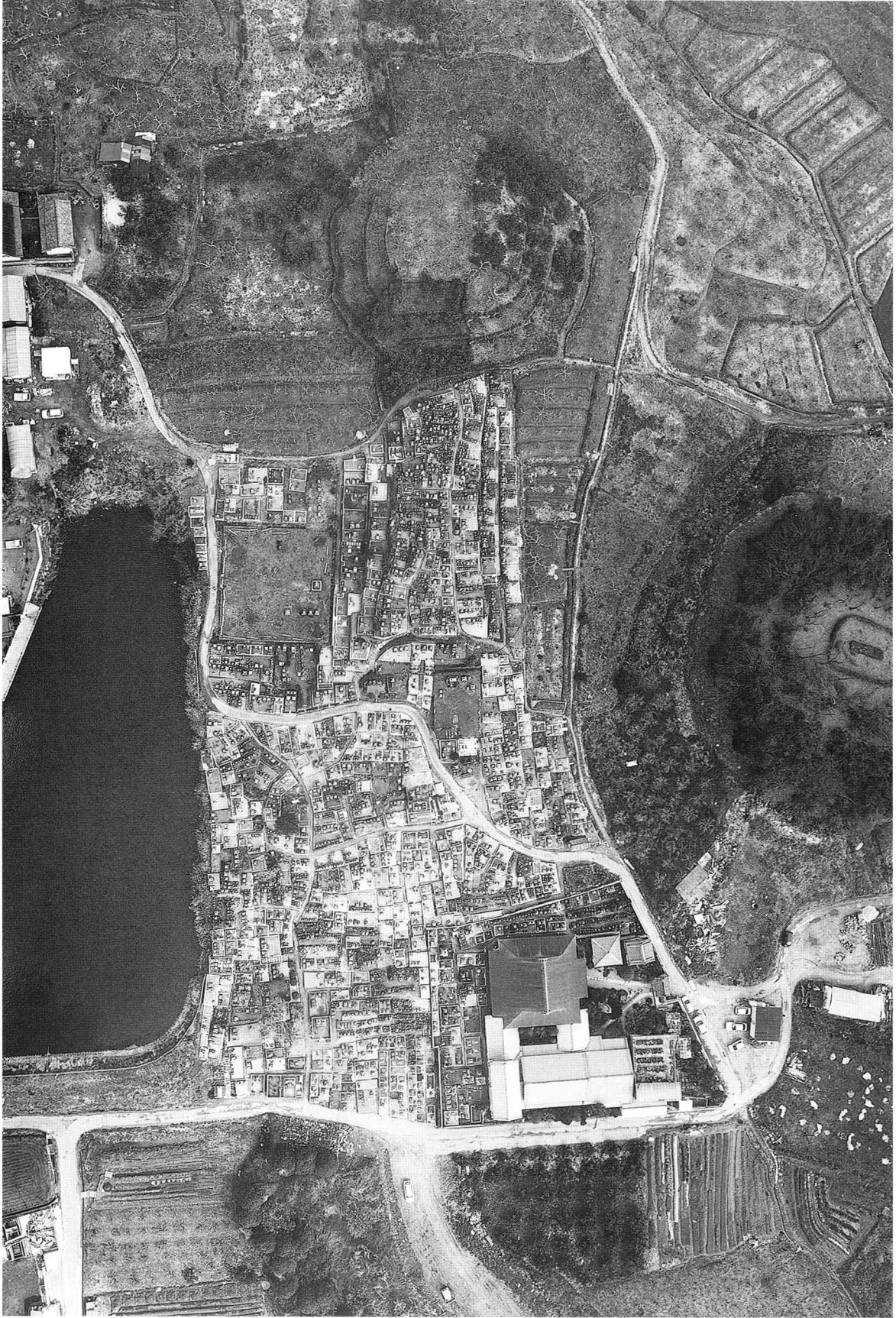
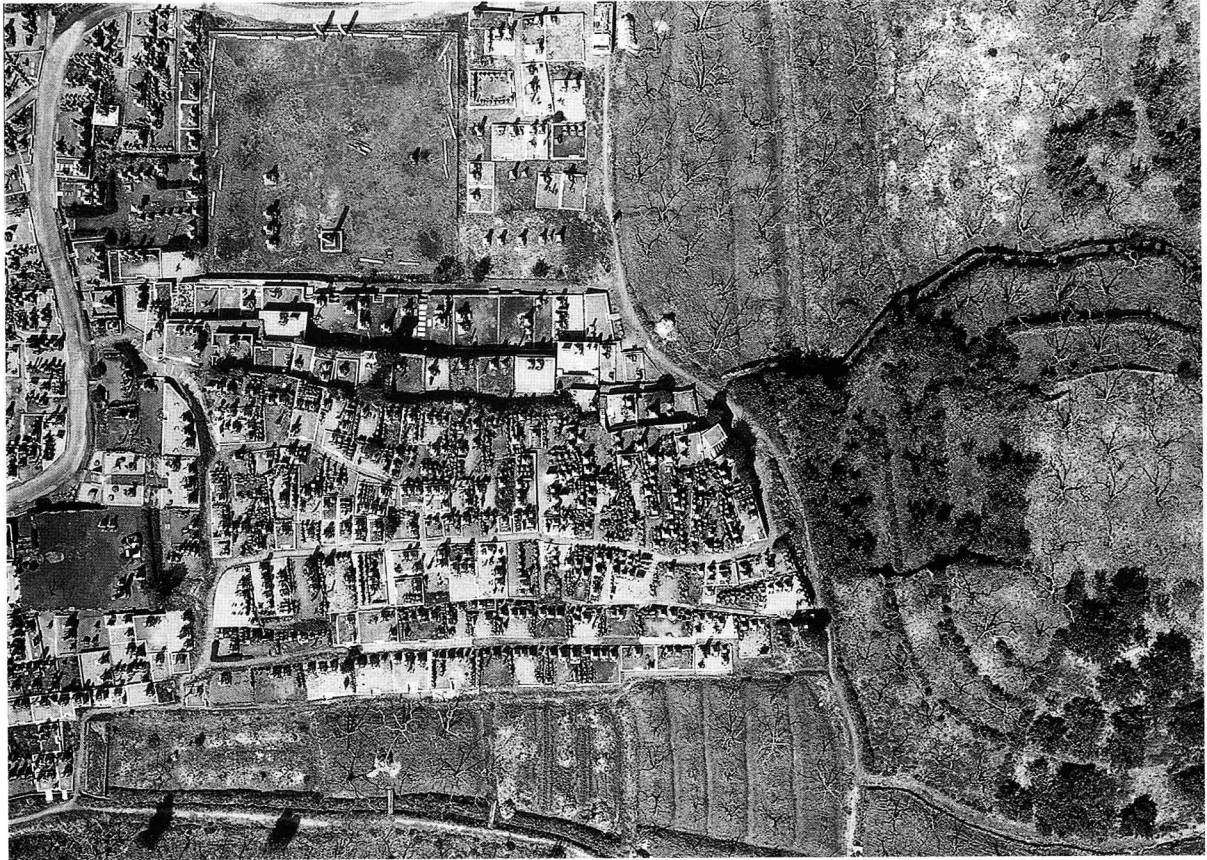

2 墓地遠景（下池山古墳上から）



3 墓地の様子（燈籠山古墳前方部上から）



4 中山念仏寺山門



5 墓地入口付近



1 大型五輪塔付近から



2 念仏寺側から



3 旧来のままの墓道 (B, E区)



4 新しい区画 (C区)



5 近世石塔密集地 (D区)



6 前方部側に向かって (E区)



7 遠くに二上山を望む (E区)



8 「山辺の道」に面する区画 (E区)



1 「山辺の道」に面する区画 (E区)



2 「山辺の道」に面する区画 (E, F区)



3 内幕 (G区) と外墓 (F区ほか)



4 内幕 (G区)



5 内幕 (G区)



6 「山辺の道」から前方部を望む (H区)



7 前方部北側縁 (H, J区)



8 前方部北付近 (H区から)



1 墓地入口付近から (I区)



2 前方部上から後円部を望む (J区)



3 後円部から見た墓地



4 中山大塚古墳から見た墓地 (J, K区)



5 前方部南側縁 (J, K区)



6 消滅前の無縁石塔群 (X区)



7 無縁塚 (Y区)



8 調査風景 (G区)



1 墓地北西部の一区画 (H区)



2 墓地北部の一区画 (B区)



3 大和神社神主の墓所 (H区)



4 近世石塔密集地 (D区)



5 前川家墓所 (B区)



6 前方面西側の一区画 (E区)



7 近世石塔密集地 (A区)

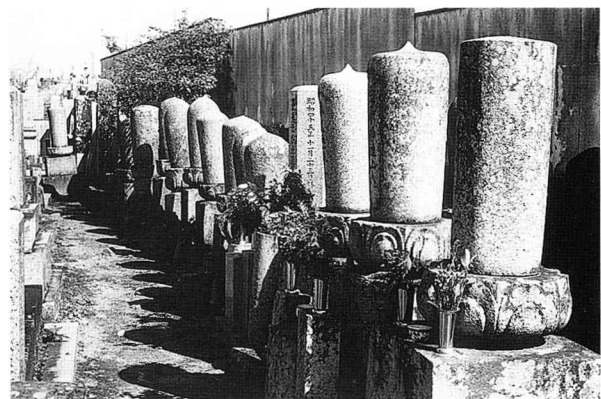

8 念仏寺歴代住職墓所 (G区)



1 大型五輪塔 (A区)



4 大型五輪塔周辺 (A区)



2 同上正面 (A区)



5 迎え地蔵「杖立て地蔵」(A区)



6 箱仏 (A区)



3 調査風景 (A区)



7 小型五輪塔 (A区)



1 行基碑と棺台 (I区)



5 行基碑 (I区)



2 行基碑台座裏銘 (I区)



6 迎え仏 (I区)



3 棺台 (I区)



7 迎え仏 (X区から駐車場へ移動)



4 六地藏 (I区)



1 有像櫛形 (G区)



2 有像舟形 (G区)



3 丸彫形 (G区)



4 箱仏 (A区)

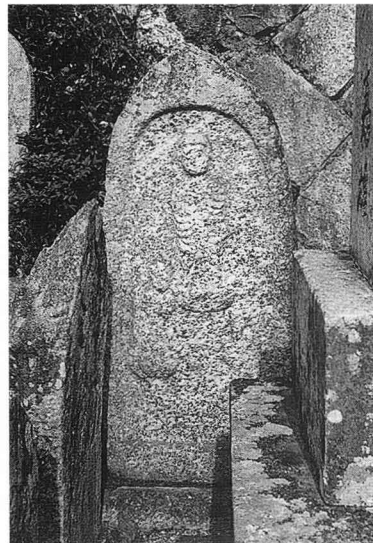

5 有像舟形 (三尊) (K区)



6 丸彫形 (Y区)

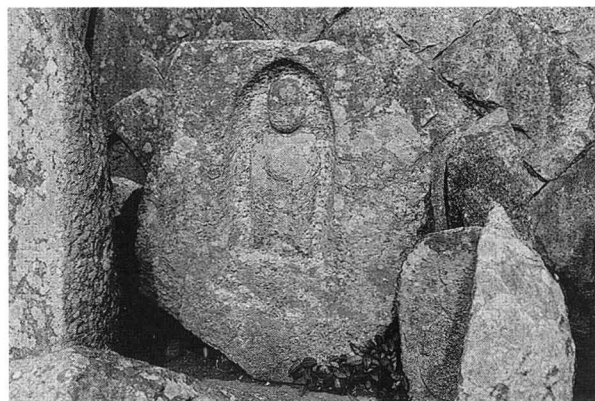

7 有像不定形 (K区)



8 地藏浮彫像「貞和五年：1349」(G区)



1 背光五輪塔 (D区)



2 不定形連立五輪塔 (B区)



3 不定形三連五輪塔 (B区)



4 別石五輪塔 (F区)

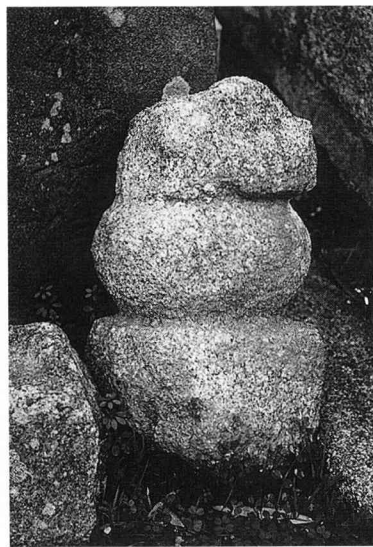

5 一石五輪塔 (C区)



6 半截五輪塔 (A区)



7 別石五輪塔 (H区)

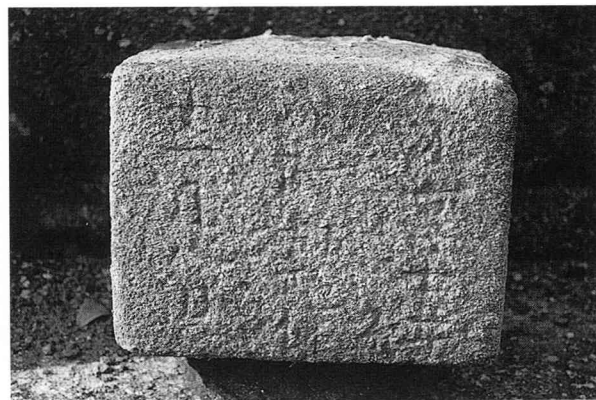

8 7の地輪「永享七年：1435」(H区)

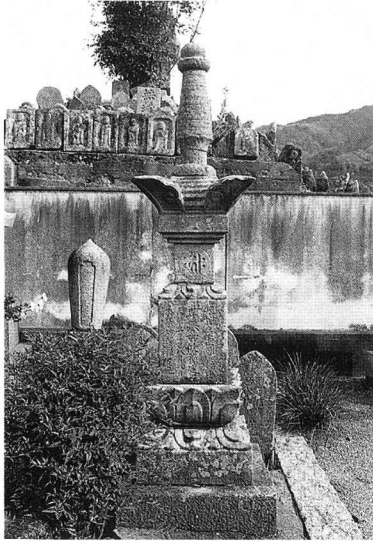

1 宝篋印塔 (G区)



2 櫛形宝篋印塔 (G区)



3 背光宝篋印塔 (K区)



4 笠塔婆 (G区)



5 無縫塔 (G区)



6 板碑形 (G区)



7 不定形「天正四年：1576」(K区)



8 7の結衆銘部 (K区)



1 平頭角柱 (F区)



2 角台頭角柱 (F区)



3 丸台頭角柱 (F区)



4 丘状頭角柱 (F区)



5 有突起角柱 (H区)



6 尖頭角柱 (A区)



7 円柱 (G区)



8 横長形 (A区)



9 駒形 (I区)



1 舟形 (C区)



2 櫛形 (F区)



3 不定形「元亀三年：1572」(K区)



4 兵庫神護寺墓地



5 竹之内宝伝寺墓地



6 佐保庄朝日寺墓地



7 調査メンバー集合写真